

# Dell PowerEdge T130 Owner's Manual

Regulatory Model: E36S Series  
Regulatory Type: E36S001



# Notes, cautions, and warnings

 **NOTE:** A NOTE indicates important information that helps you make better use of your computer.

 **CAUTION:** A CAUTION indicates either potential damage to hardware or loss of data and tells you how to avoid the problem.

 **WARNING:** A WARNING indicates a potential for property damage, personal injury, or death.

**Copyright © 2015 Dell Inc. All rights reserved.** This product is protected by U.S. and international copyright and intellectual property laws. Dell™ and the Dell logo are trademarks of Dell Inc. in the United States and/or other jurisdictions. All other marks and names mentioned herein may be trademarks of their respective companies.

2015 - 09

Rev. A00

# Contents

<b>1 About the Dell PowerEdge T130 system.....</b>	<b>8</b>
Front panel features and indicators.....	8
Diagnostic indicators.....	9
Back panel features and indicators.....	11
NIC indicator codes.....	13
Power indicator codes for power supply unit.....	13
Documentation matrix.....	14
Accessing system information by using QRL.....	15
<b>2 Performing initial system configuration .....</b>	<b>17</b>
Setting up your system.....	17
Setting up and configuring the iDRAC IP address .....	17
Logging in to iDRAC.....	18
Methods of installing the operating system.....	18
Managing your system remotely.....	18
Downloading drivers and firmware.....	18
<b>3 Pre-operating system management applications.....</b>	<b>20</b>
Navigation keys.....	20
About system setup.....	21
Entering System Setup.....	21
System Setup Main Menu.....	21
System BIOS screen details.....	21
System Information screen details.....	22
Memory Settings screen details.....	23
Processor Settings screen details.....	23
SATA Settings screen details.....	24
Boot Settings screen details.....	26
Network Settings screen details.....	27
UEFI iSCSI Settings screen details.....	27
Integrated Devices screen details.....	27
Serial Communication screen details.....	28
System Profile Settings screen details.....	29
System Security Settings screen details.....	30
Miscellaneous Settings screen details.....	32
About Boot Manager.....	33
Entering Boot Manager.....	33
Boot Manager main menu.....	33

About Dell Lifecycle Controller.....	33
Changing the boot order.....	33
Choosing the system boot mode.....	34
Creating a system or setup password.....	34
Using your system password to secure your system.....	35
Deleting or changing system password and setup password.....	35
Operating with a setup password enabled.....	36
Embedded system management.....	36
iDRAC Settings utility.....	36
Entering the iDRAC settings utility.....	36
Changing the thermal settings.....	37

## **4 Installing and removing system components.....38**

Safety instructions.....	38
Before working inside your system.....	38
After working inside your system.....	38
Recommended tools.....	39
System cover.....	39
Removing the system cover.....	39
Installing the system cover.....	40
Bezel.....	41
Removing the bezel.....	41
Installing the bezel.....	42
Inside the system.....	43
Intrusion switch.....	44
Removing the intrusion switch.....	44
Installing the intrusion switch.....	45
Control panel assembly.....	45
Removing the control panel assembly.....	45
Installing the control panel assembly.....	47
Hard drives.....	47
Removing the hard drive cage.....	48
Installing the hard drive cage.....	49
Removing a hard drive carrier from the hard drive cage.....	50
Installing a hard drive carrier into the hard drive cage.....	52
Removing a hard drive carrier from the hard drive bay.....	52
Installing a hard drive carrier into the hard drive bay.....	53
Removing a hard drive from a hard drive carrier.....	54
Installing a hard drive into a hard drive carrier.....	55
Hard drive cabling diagrams.....	56
Setting the cooling fan speed for 4 TB hard drives.....	57
Optical drive.....	58

Removing the optical drive blank and filler.....	58
Removing the optical drive.....	60
Installing the optical drive.....	62
System memory.....	62
General memory module installation guidelines.....	64
Sample memory configurations.....	64
Removing memory modules.....	65
Installing memory modules.....	66
Cooling fan.....	67
Removing the cooling fan.....	68
Installing the cooling fan.....	69
Internal USB memory key (optional).....	69
Replacing the optional internal USB memory key.....	70
Expansion cards.....	71
Expansion card installation guidelines.....	71
Removing an expansion card.....	72
Installing an expansion card.....	73
iDRAC port card (optional).....	74
Replacing an optional SD vFlash card.....	74
Removing the optional iDRAC port card.....	75
Installing the optional iDRAC port card.....	76
Processors and heat sinks.....	77
Removing the heat sink.....	77
Removing the processor.....	79
Installing the processor.....	81
Installing the heat sink.....	82
Power supply unit.....	84
Removing the power supply unit (PSU).....	84
Installing the power supply unit (PSU).....	86
System battery.....	86
Replacing the system battery.....	86
System board.....	88
Removing the system board.....	88
Installing the system board.....	90
Entering the system service tag by using System Setup.....	91
Trusted Platform Module.....	92
Installing the Trusted Platform Module.....	92
Re-enabling the TPM for BitLocker users.....	93
Re-enabling the TPM for TXT users.....	93
<b>5 Troubleshooting your system.....</b>	<b>95</b>
Safety first—for you and your system.....	95

Troubleshooting system startup failure.....	95
Troubleshooting external connections.....	95
Troubleshooting the video subsystem.....	95
Troubleshooting a USB device.....	95
Troubleshooting a serial I/O device.....	96
Troubleshooting an NIC.....	97
Troubleshooting a wet system.....	97
Troubleshooting a damaged system.....	98
Troubleshooting the system battery.....	99
Troubleshooting power supply units.....	99
Troubleshooting power source problems.....	99
Power supply unit problems.....	99
Troubleshooting cooling problems.....	100
Troubleshooting cooling fans.....	101
Troubleshooting system memory.....	101
Troubleshooting an internal USB key.....	102
Troubleshooting an SD card.....	103
Troubleshooting an optical drive.....	103
Troubleshooting a hard drive.....	104
Troubleshooting a storage controller.....	104
Troubleshooting expansion cards.....	105
Troubleshooting processors.....	106
System messages.....	106
Warning messages.....	106
Diagnostic messages.....	107
Alert messages.....	107
<b>6 Using system diagnostics.....</b>	<b>108</b>
Dell Embedded System Diagnostics.....	108
When to use the Embedded System Diagnostics.....	108
Running the Embedded System Diagnostics from Boot Manager.....	108
Running the Embedded System Diagnostics from the Dell Lifecycle Controller.....	108
System diagnostics controls.....	109
<b>7 Jumpers and connectors.....</b>	<b>110</b>
System board jumpers and connectors.....	110
System board jumper settings.....	112
Disabling a forgotten password.....	112
<b>8 Technical specifications.....</b>	<b>114</b>
Dimensions and weight.....	114
Processor specifications.....	114

Expansion bus specifications.....	114
Memory specifications.....	114
Power specifications.....	115
Storage controller specifications.....	115
Drive specifications.....	115
Connectors specifications.....	116
Video specifications.....	116
Environmental specifications.....	116
<b>9 Getting help.....</b>	<b>119</b>
Contacting Dell.....	119
Locating your system Service Tag.....	119

# About the Dell PowerEdge T130 system

The Dell PowerEdge T130 tower server supports one processor based on the Intel E3-1200 V5 series, up to four DIMMs, and storage capacity of up to four 3.5-inch cabled hard drives.

## Front panel features and indicators

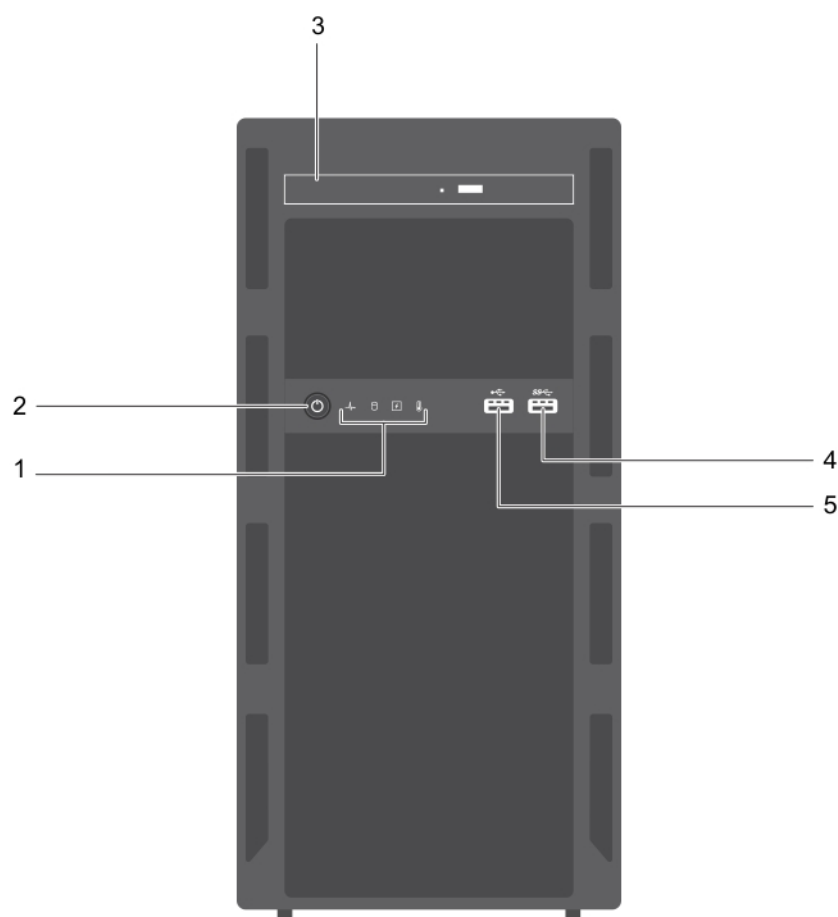





Figure 1. Front panel features and indicators



**Table 1. Front panel features and indicators**

Item	Indicator, button, or connector	Icon	Description
1	Diagnostic indicators		Enables you to view error status during system startup. The diagnostic indicators are located on the system front panel. For more information, see <a href="#">Diagnostic indicators</a> .
2	Power-on indicator, power button		Enables you to know the power status of the system. The power-on indicator glows when the system power is on. The power button controls the power supply output to the system.   <b>NOTE:</b> On ACPI-compliant operating systems, turning off the system using the power button causes the system to perform a graceful shutdown before power to the system is turned off.
3	Optical drive (optional)		Enables you to install an optional slim SATA DVD-ROM drive or DVD+/-RW drive.
4	USB connector		Enables you to connect USB devices to the system. This port is USB 3.0 compliant.
5	USB connector		Enables you to connect USB devices to the system. This port is USB 2.0 compliant.



## Diagnostic indicators

The diagnostic indicators on the system front panel display error status during system startup.

 **NOTE:** No diagnostic indicators are lit when the system is switched off. To start the system, plug it into a working power source and press the power button.

**Table 2. Diagnostic indicators**

Icon	Description	Condition	Corrective action
	Health indicator	If the system is on and in good health, the indicator turns solid blue.  The indicator flashes amber if the system is on or in standby, and if any error exists (for example, a failed fan or hard drive).	None required.  Check the System Event Log or system messages for the specific issue. For more information about error messages, see the Dell Event and Error Messages Reference Guide at <a href="http://Dell.com/openmanagemanuals">Dell.com/openmanagemanuals</a> > <b>OpenManage software</b> .  Invalid memory configurations can cause the system to halt at startup without any video output. See <a href="#">Getting help</a> .

Icon	Description	Condition	Corrective action
	Hard drive indicator	The indicator flashes amber if there is a hard drive error.	Check the System Event Log to determine the hard drive that has an error. Run the appropriate Online Diagnostics test. Restart the system and run embedded diagnostics (ePSA). If the hard drives are configured in a RAID array, restart the system and enter the host adapter configuration utility program.
	Electrical indicator	The indicator flashes amber if the system experiences an electrical error (for example, voltage out of range, or a failed power supply unit (PSU) or voltage regulator).	Check the System Event Log or system messages for the specific issue. If it is due to a problem with the PSU, check the LED on the PSU. Reseat the PSU. If the problem persists, see <a href="#">Getting help</a> .
	Temperature indicator	The indicator flashes amber if the system experiences a thermal error (for example, a temperature out of range or fan failure).	Ensure that none of the following conditions exist: <ul style="list-style-type: none"> <li>• A cooling fan is removed or has failed.</li> <li>• System cover, memory module blank, or back filler bracket is removed.</li> <li>• Ambient temperature is too high.</li> <li>• External airflow is obstructed.</li> </ul> See <a href="#">Getting help</a> .

## Back panel features and indicators

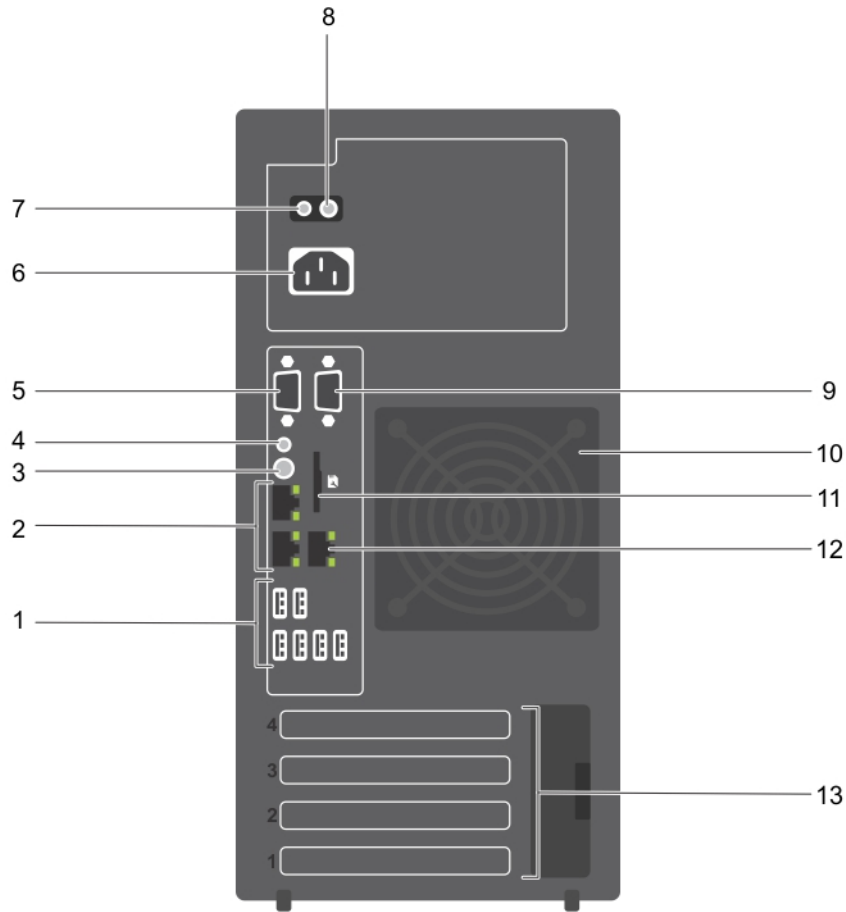







Figure 2. Back panel features and indicators

Table 3. Back panel features and indicators

Item	Indicator, Button or Connector	Icon	Description
1	USB connectors (6)		Enables you to connect USB devices to the system. There are four USB 2.0 compliant ports and two USB 3.0 compliant ports.
2	Ethernet connectors (2)		Enable you to connect to the Integrated 10/100/1000 Mbps NIC connectors.
3	System identification button		Enables you to locate a particular system. When this button is pressed, the system status indicator on the back flashes until the button is pressed again.

Item	Indicator, Button or Connector	Icon	Description
			<p>To turn the system ID indicator on or off, press the system identification button.</p> <p>If the system stops responding during POST, press and hold the system ID button for more than five seconds to enter the BIOS progress mode.</p> <p>To reset iDRAC (if not disabled in F2 iDRAC setup), press and hold the system identification button for more than 15 seconds.</p>
4	System identification connector		Enables you to connect the optional system status indicator assembly through the optional cable management arm.
5	Video connector		Enables you to connect a VGA display to the system.
6	Power supply		Enables you to install one 290 W non-redundant AC PSU.
7	Self-diagnostic button		Enables you to check the health status of the PSU.
8	AC power supply status indicator		Enables you to check the power supply to the PSU.
9	Serial connector		Enables you to connect a serial device to the system.
10	Cooling fan		The system cooling fan.
11	VFlash		Enables you to connect the vFlash card (optional).
12	Ethernet connector (1)		Enables you to install a dedicated management port card (optional).
13	Expansion card slots (4)		Enables you to connect up to four full-height PCIe expansion cards.



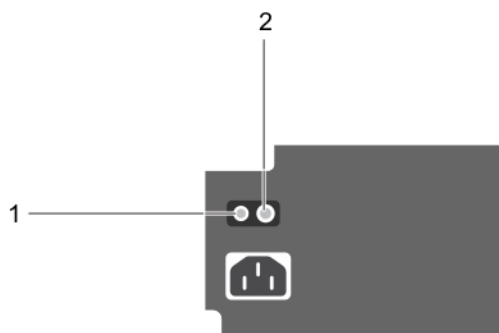

**Figure 4. PSU status indicator and self-diagnostic button**

- 1. self-diagnostic button
- 2. PSU status indicator

PSU status indicator	Condition
Not lit	Power is not connected or PSU is faulty.
Green	A valid power source is connected to the PSU and the PSU is operational.

## Documentation matrix

The documentation matrix provides information on documents that you can refer to for setting up and managing your system.

**Table 5. Documentation matrix**

To...	See the...
Install your system into a rack	Rack documentation included with your rack solution
Set up your system and know the system technical specifications	<i>Getting Started With Your System</i> that shipped with your system or see <b>Dell.com/poweredgemanuals</b>
Install the operating system	Operating system documentation at <b>Dell.com/operatingsystemmanuals</b>
Get an overview of the Dell Systems Management offerings	Dell OpenManage Systems Management Overview Guide at <b>Dell.com/openmanagemanuals &gt; OpenManage software</b>
Configure and log in to iDRAC, set up managed and management system, know the iDRAC features, and troubleshoot by using iDRAC	Integrated Dell Remote Access Controller User's Guide at <b>Dell.com/idracmanuals</b>

To...	See the...
Know about the RACADM subcommands and supported RACADM interfaces	RACADM Command Line Reference Guide for iDRAC at <a href="http://Dell.com/idracmanuals">Dell.com/idracmanuals</a>
Launch, enable, and disable Dell Lifecycle Controller, know the features, use and troubleshoot Dell Lifecycle Controller	Dell Lifecycle Controller User's Guide at <a href="http://Dell.com/idracmanuals">Dell.com/idracmanuals</a>
Use Dell Lifecycle Controller Remote Services	Dell Lifecycle Controller Remote Services Quick Start Guide at <a href="http://Dell.com/idracmanuals">Dell.com/idracmanuals</a>
Set up, use, and troubleshoot OpenManage Server Administrator	Dell OpenManage Server Administrator User's Guide at <a href="http://Dell.com/openmanagemanuals">Dell.com/openmanagemanuals</a> > <b>OpenManage Server Administrator</b>
Install, use, and troubleshoot OpenManage Essentials	Dell OpenManage Essentials User's Guide at <a href="http://Dell.com/openmanagemanuals">Dell.com/openmanagemanuals</a> > <b>OpenManage Essentials</b>
Know the features of the storage controller cards, deploy the cards, and manage the storage subsystem	Storage controller documentation at <a href="http://Dell.com/storagecontrollermanuals">Dell.com/storagecontrollermanuals</a>
Check the event and error messages generated by the system firmware and agents that monitor system components	Dell Event and Error Messages Reference Guide at <a href="http://Dell.com/openmanagemanuals">Dell.com/openmanagemanuals</a> > <b>OpenManage software</b>

## Accessing system information by using QRL

You can use the Quick Resource Locator (QRL) to get immediate access to the information about your system.

### Prerequisites

Ensure that your smartphone or tablet has the QR code scanner installed.

### About this task

The QRL includes the following information about your system:

- How-to videos
- Reference materials, including the Owner's Manual, LCD diagnostics, and mechanical overview
- Your system service tag to quickly access your specific hardware configuration and warranty information
- A direct link to Dell to contact technical support and sales teams

### Steps

1. Go to [Dell.com/QRL](http://Dell.com/QRL) and navigate to your specific product or
2. Use your smartphone or tablet to scan the model-specific Quick Resource (QR) code located in the following image or on your Dell PowerEdge system:





# Performing initial system configuration

After you receive your system, you must set up your system, install the operating system if it is not pre-installed, and set up and configure the system iDRAC IP address.

## Setting up your system

1. Unpack the server.
2. Connect the peripherals to the system.
3. Connect the system to its electrical outlet.
4. Turn on the system by pressing the power button or using iDRAC.
5. Turn on the attached peripherals.

## Setting up and configuring the iDRAC IP address

You can set up the Integrated Dell Remote Access Controller (iDRAC) IP address by using one of the following interfaces:

- iDRAC Settings utility
- Dell Lifecycle Controller
- Dell OpenManage Deployment Toolkit
- Server LCD panel

You can use the default iDRAC IP address 192.168.0.120 to configure the initial network settings, including setting up DHCP or a static IP for iDRAC.

 **NOTE:** To access iDRAC, ensure that you install the iDRAC port card or connect the network cable to the Ethernet connector 1 on the system board.

You can configure iDRAC IP address by using the following interfaces:

 **NOTE:** Make sure that you change the default user name and password after setting up the iDRAC IP address.

- iDRAC web interface — For more information, see the Integrated Dell Remote Access Controller User's Guide.
- Remote Access Controller Admin (RACADM) — For more information, see the RACADM Command Line Interface Reference Guide and the Integrated Dell Remote Access Controller User's Guide.
- Remote Services that include Web Services Management (WS-Man) — For more information, see the Dell Lifecycle Controller Remote Services Quick Start Guide.

For more information about setting up and configuring iDRAC, see the Integrated Dell Remote Access Controller User's Guide at [Dell.com/idracmanuals](http://Dell.com/idracmanuals).

## Logging in to iDRAC

You can log in to iDRAC as an iDRAC local user, a Microsoft Active Directory user, or a Lightweight Directory Access Protocol (LDAP) user. You can also log in by using Single Sign-On or a Smart Card. The default user name is **root** and password is **calvin**. For more information about logging in to iDRAC and iDRAC licenses, see the Integrated Dell Remote Access Controller User's Guide at [Dell.com/idracmanuals](http://Dell.com/idracmanuals).

You can also access iDRAC by using RACADM. For more information, see the RACADM Command Line Interface Reference Guide and the Integrated Dell Remote Access Controller User's Guide available at [Dell.com/idracmanuals](http://Dell.com/idracmanuals).

## Methods of installing the operating system

If the system is shipped without an operating system, install the supported operating system on the system by using one of the following methods:

- Dell Systems Management Tools and Documentation media — see the operating system documentation at [Dell.com/operatingsystemmanuals](http://Dell.com/operatingsystemmanuals).
- Dell Lifecycle Controller — see the Dell Lifecycle Controller documentation at [Dell.com/idracmanuals](http://Dell.com/idracmanuals).
- Dell OpenManage Deployment Toolkit — see the Dell OpenManage documentation at [Dell.com/openmanagemanuals](http://Dell.com/openmanagemanuals) > **OpenManage software**.

For information on the list of operating systems supported on your system, see the operating system's support matrix at [Dell.com/ossupport](http://Dell.com/ossupport).

## Managing your system remotely

To perform out-of-band systems management using iDRAC, you must configure iDRAC for remote accessibility, set up the management station and managed system, and configure the supported Web browsers. For more information, see the Integrated Dell Remote Access Controller User's Guide at [Dell.com/idracmanuals](http://Dell.com/idracmanuals).

You can also remotely monitor and manage the server by using the Dell OpenManage Server Administrator (OMSA) software and OpenManage Essentials (OME) systems management console. For more information, see [Dell.com/openmanagemanuals](http://Dell.com/openmanagemanuals) > **OpenManage Server Administrator** or [Dell.com/openmanagemanuals](http://Dell.com/openmanagemanuals) > **OpenManage Essentials**.

## Downloading drivers and firmware

It is recommended that you download and install the latest BIOS, drivers, and systems management firmware on your system.

### Prerequisites

Ensure that you clear the web browser cache.

## Steps

1. Go to **Dell.com/support/drivers**.
2. In the **Product Selection** section, enter the Service Tag of your system in the **Service Tag or Express Service Code** field.  
 **NOTE:** If you do not have the Service Tag, select **Automatically detect my Service Tag** for me to enable the system to automatically detect your service tag, or select your product from the **Product Selection** page.
3. Click **Get drivers and downloads**.  
The drivers that are applicable to your selection are displayed.
4. Download the drivers that you need to a USB drive, CD, or DVD.

# Pre-operating system management applications

The pre-operating system management applications for your system help you manage different settings and features without booting to the operating system.

Your system has the following pre-operating system management applications:

- System Setup
- Boot Manager
- Dell Lifecycle Controller
- Preboot Execution Environment (PXE)

## Navigation keys

The navigation keys can help you quickly access the pre-operating system management applications.

Key	Description
F2	Enables you to enter <b>System Setup</b> .
F10	Enables you to enter system services and starts <b>Lifecycle Controller</b> .
F11	Enables you to enter <b>Boot Manager</b> .
F12	Enables you to enter <b>PXE Boot</b> .
Page Up	Enables you to move to the previous screen.
Page Down	Enables you to move to the next screen.
Up arrow	Enables you to move to the previous field.
Down arrow	Enables you to move to the next field.
Enter	Enables you to type a value in the selected field (if applicable).
Spacebar	Enables you to expand or collapse a drop-down list, if applicable.
Tab	Enables you to move to the next menu item.
	 <b>NOTE:</b> This feature is applicable only for the standard graphic browser.
Esc	Enables you to move to the previous page until you view the main screen. Pressing Esc in the main screen exits <b>System BIOS, iDRAC Settings, Device Settings, or Service Tag Settings</b> , and proceeds with system boot.
F1	Displays the system setup help.

## About system setup

By using the **System Setup** screen, you can configure the BIOS settings, iDRAC settings, and device settings of your system.

 **NOTE:** Help text for the selected field is displayed in the graphical browser by default. To view the help text in the text browser, press F1.

You can access system setup in two ways:

- Standard graphical browser — The browser is enabled by default.
- Text Browser — The browser is enabled by using Console Redirection.

### Entering System Setup

1. Turn on, or restart your system.
2. Press F2 immediately after you see the following message:  
F2 = System Setup

If your operating system begins to load before you press F2, wait for the system to finish booting, and then restart your system and try again.

### System Setup Main Menu

The **System Setup Main Menu** screen details are explained as follows:

Option	Description
<b>System BIOS</b>	Enables you to configure BIOS settings.
<b>iDRAC Settings</b>	Enables you to configure iDRAC settings. The iDRAC settings utility is an interface to set up and configure the iDRAC parameters by using UEFI. You can enable or disable various iDRAC parameters by using the iDRAC settings utility. For more information about this utility, see <i>Integrated Dell Remote Access Controller User's Guide</i> at <a href="http://Dell.com/idracmanuals">Dell.com/idracmanuals</a> .
<b>Device Settings</b>	Enables you to configure device settings.

### System BIOS screen details

You can use the **System BIOS** screen to edit specific functions such as boot order, system password, setup password, set the RAID mode, and enable or disable USB ports.

To view the **System BIOS** screen, click **System Setup Main Menu** → **System BIOS**.

The **System BIOS** screen details are explained as follows:

Option	Description
<b>System Information</b>	Displays information about the system such as the system model name, BIOS version, and Service Tag.
<b>Memory Settings</b>	Displays information and options related to the installed memory.

Option	Description
<b>Processor Settings</b>	Displays information and options related to the processor such as speed, cache size.
<b>SATA Settings</b>	Displays options to enable or disable the integrated SATA controller and ports.
<b>Boot Settings</b>	Displays options to specify the boot mode (BIOS or UEFI). Enables you to modify UEFI and BIOS boot settings.
<b>Network Settings</b>	Displays options to change the network settings.
<b>Integrated Devices</b>	Displays options to manage integrated device controllers and ports and specify related features and options.
<b>Serial Communication</b>	Displays options to manage the serial ports and specify related features and options.
<b>System Profile Settings</b>	Displays options to change the processor power management settings, memory frequency, and so on.
<b>System Security</b>	Displays options to configure the system security settings, such as system password, setup password, Trusted Platform Module (TPM) security. It also manages the power and NMI buttons on the system.
<b>Miscellaneous Settings</b>	Displays options to change the system date, time, and so on.

## System Information screen details

You can use the **System Information** screen to view system properties such as Service Tag, system model name, and the BIOS version.

To view the **System Information** screen, click **System Setup Main Menu** → **System BIOS** → **System Information**.

The **System Information** screen details are explained as follows:

Option	Description
<b>System Model Name</b>	Displays the system model name.
<b>System BIOS Version</b>	Displays the BIOS version installed on the system.
<b>System Management Engine Version</b>	Displays the current version of the Management Engine firmware.
<b>System Service Tag</b>	Displays the system Service Tag.
<b>System Manufacturer</b>	Displays the name of the system manufacturer.
<b>System Manufacturer Contact Information</b>	Displays the contact information of the system manufacturer.
<b>System CPLD Version</b>	Displays the current version of the system complex programmable logic device (CPLD) firmware.

Option	Description
<b>UEFI Compliance Version</b>	Displays the UEFI compliance level of the system firmware.

## Memory Settings screen details

You can use the **Memory Settings** screen to view all the memory settings and enable or disable specific memory functions, such as system memory testing and node interleaving. To view the **Memory Setting** screen, click **System Setup Main Menu** → **System BIOS** → **Memory Settings**. The **Memory Settings** screen details are explained as follows:



Option	Description
<b>System Memory Size</b>	Displays the amount of memory installed in the system.
<b>System Memory Type</b>	Displays the type of memory installed in the system.
<b>System Memory Speed</b>	Displays the system memory speed.
<b>System Memory Voltage</b>	Displays the system memory voltage.
<b>Video Memory</b>	Displays the amount of video memory.
<b>System Memory Testing</b>	Specifies whether the system memory tests are run during system boot. Options are <b>Enabled</b> and <b>Disabled</b> . This option is set to <b>Disabled</b> by default.
<b>Memory Operating Mode</b>	Specifies the memory operating mode. The available option is <b>Optimizer Mode</b> .

## Processor Settings screen details

You can use the **Processor Settings** screen to view the processor settings, and perform specific functions such as enabling virtualization technology, hardware prefetcher and logical processor idling. To view the **Processor Settings** screen, click **System Setup Main Menu** → **System BIOS** → **Processor Settings**.

The **Processor Settings** screen details are explained as follows:

Option	Description
<b>Logical Processor</b>	Enables or disables the logical processors and displays the number of logical processors. If this option is set to <b>Enabled</b> , the BIOS displays all the logical processors. If this option is set to <b>Disabled</b> , the BIOS displays only one logical processor per core. This option is set to <b>Enabled</b> by default.
<b>Virtualization Technology</b>	Enables or disables the additional hardware capabilities provided for virtualization. This option is set to <b>Enabled</b> by default.
<b>Adjacent Cache Line Prefetch</b>	Optimizes the system for applications that require high utilization of sequential memory access. This option is set to <b>Enabled</b> by default. You can disable this option for applications that require high utilization of random memory access.
<b>Hardware Prefetcher</b>	Enables or disables the hardware prefetcher. This option is set to <b>Enabled</b> by default.

Option	Description										
<b>DCU Streamer Prefetcher</b>	Enables or disables the Data Cache Unit (DCU) streamer prefetcher. This option is set to <b>Enabled</b> by default.										
<b>DCU IP Prefetcher</b>	Enables or disables the Data Cache Unit (DCU) IP prefetcher. This option is set to <b>Enabled</b> by default.										
<b>Configurable TDP</b>	Enables you to reconfigure the processor Thermal Design Power (TDP) levels during POST based on the power and thermal delivery capabilities of the system. TDP verifies the maximum heat the cooling system is required to dissipate. This option is set to <b>Nominal</b> by default.   <b>NOTE:</b> This option is only available on certain stock keeping units (SKUs) of the processors.										
<b>X2Apic Mode</b>	Enables or disables the X2Apic mode.										
<b>Dell Controlled Turbo</b>	Controls the turbo engagement. Enable this option only when <b>System Profile</b> is set to <b>Performance</b> .   <b>NOTE:</b> Depending on the number of installed CPUs, there may be up to four processor listings.										
<b>Number of Cores per Processor</b>	Controls the number of enabled cores in each processor. This option is set to <b>All</b> by default.										
<b>Processor 64-bit Support</b>	Specifies if the processor(s) support 64-bit extensions.										
<b>Processor Core Speed</b>	Displays the maximum core frequency of the processor.										
<b>Processor 1</b>	The following settings are displayed for each processor installed in the system: <table border="1" data-bbox="478 1113 1197 1327"> <thead> <tr> <th>Option</th> <th>Description</th> </tr> </thead> <tbody> <tr> <td><b>Brand</b></td> <td>Displays the brand name.</td> </tr> <tr> <td><b>Level 2 Cache</b></td> <td>Displays the total L2 cache.</td> </tr> <tr> <td><b>Level 3 Cache</b></td> <td>Displays the total L3 cache.</td> </tr> <tr> <td><b>Number of Cores</b></td> <td>Displays the number of cores per processor.</td> </tr> </tbody> </table>	Option	Description	<b>Brand</b>	Displays the brand name.	<b>Level 2 Cache</b>	Displays the total L2 cache.	<b>Level 3 Cache</b>	Displays the total L3 cache.	<b>Number of Cores</b>	Displays the number of cores per processor.
Option	Description										
<b>Brand</b>	Displays the brand name.										
<b>Level 2 Cache</b>	Displays the total L2 cache.										
<b>Level 3 Cache</b>	Displays the total L3 cache.										
<b>Number of Cores</b>	Displays the number of cores per processor.										

## SATA Settings screen details

You can use the **SATA Settings** screen to view the SATA settings of SATA devices and enable RAID on your system.

To view the **SATA Settings** screen, click **System Setup Main Menu** → **System BIOS** → **SATA Settings**.

The **SATA Settings** screen details are explained as follows:

Option	Description
<b>Embedded SATA</b>	Enables the embedded SATA option to be set to <b>Off</b> , <b>AHCI</b> , or <b>RAID</b> modes. This option is set to <b>AHCI</b> by default.
<b>Security Freeze Lock</b>	Sends Security Freeze Lock command to the Embedded SATA drives during POST. This option is applicable only for AHCI mode.



Option	Description
<b>Write Cache</b>	Enables or disables the command for Embedded SATA drives during POST.
<b>Port A</b>	For <b>AHCI</b> or <b>RAID</b> mode, BIOS support is always enabled.

Option	Description
<b>Model</b>	Displays the drive model of the selected device.
<b>Drive Type</b>	Displays the type of drive attached to the SATA port.
<b>Capacity</b>	Displays the total capacity of the hard drive. This field is undefined for removable media devices such as optical drives.

**Port B** For **AHCI** or **RAID** mode, BIOS support is always enabled.

Option	Description
<b>Model</b>	Displays the drive model of the selected device.
<b>Drive Type</b>	Displays the type of drive attached to the SATA port.
<b>Capacity</b>	Displays the total capacity of the hard drive. This field is undefined for removable media devices such as optical drives.

**Port C** For **AHCI** or **RAID** mode, BIOS support is always enabled.

Option	Description
<b>Model</b>	Displays the drive model of the selected device.
<b>Drive Type</b>	Displays the type of drive attached to the SATA port.
<b>Capacity</b>	Displays the total capacity of the hard drive. This field is undefined for removable media devices such as optical drives.

**Port D** For **AHCI** or **RAID** mode, BIOS support is always enabled.

Option	Description
<b>Model</b>	Displays the drive model of the selected device.
<b>Drive Type</b>	Displays the type of drive attached to the SATA port.
<b>Capacity</b>	Displays the total capacity of the hard drive. This field is undefined for removable media devices such as optical drives.

**Port E** For **AHCI** or **RAID** mode, BIOS support is always enabled.

Option	Description
<b>Model</b>	Displays the drive model of the selected device.

Option	Description
<b>Option</b>	<b>Description</b>
<b>Drive Type</b>	Displays the type of drive attached to the SATA port.
<b>Capacity</b>	Displays the total capacity of the hard drive. This field is undefined for removable media devices such as optical drives.

**Port F** For **AHCI** or **RAID** mode, BIOS support is always enabled.

Option	Description
<b>Model</b>	Displays the drive model of the selected device.
<b>Drive Type</b>	Displays the type of drive attached to the SATA port.
<b>Capacity</b>	Displays the total capacity of the hard drive. This field is undefined for removable media devices such as optical drives.

## Boot Settings screen details

You can use the **Boot Settings** screen to set the boot mode to either **BIOS** or **UEFI**. It also enables you to specify the boot order.

To view the **Boot Settings** screen, click **System Setup Main Menu** → **System BIOS** → **Boot Settings**.

The **Boot Settings** screen details are explained as follows:

Option	Description
<b>Boot Mode</b>	<p>Enables you to set the boot mode of the system. Setting this field to <b>UEFI</b> disables the <b>BIOS Boot Settings</b> menu. Setting this field to <b>BIOS</b> disables the <b>UEFI Boot Settings</b> menu.</p> <p> <b>CAUTION: Switching the boot mode may prevent the system from booting if the operating system is not installed in the same boot mode.</b></p> <p>If the operating system supports UEFI, you can set this option to <b>UEFI</b>. Setting this field to <b>BIOS</b> allows compatibility with non-UEFI operating systems. This option is set to <b>BIOS</b> by default.</p>
<b>Boot Sequence Retry</b>	Enables or disables the Boot Sequence Retry feature. If this field is enabled and the system fails to boot, the system reattempts the boot sequence after 30 seconds. This option is set to <b>Enabled</b> by default.
<b>Hard-Disk Failover</b>	Specifies the hard drive that is booted in the event of a hard drive failure. The devices are selected in the <b>Hard-Disk Drive Sequence</b> on the <b>Boot Option Setting</b> menu. When this option is set to <b>Disabled</b> , only the first hard drive in the list is attempted to boot. When this option is set to <b>Enabled</b> , all hard drives are attempted to boot in the order selected in the <b>Hard-Disk Drive Sequence</b> . This option is not enabled for UEFI Boot Mode.
<b>Boot Option Settings</b>	Configures the boot sequence and the boot devices.

## Network Settings screen details

You can use the **Network Settings** screen to modify PXE device settings. The network settings option is available only in the UEFI boot mode. BIOS does not control network settings in the BIOS boot mode. For BIOS boot mode, the option ROM of the network controllers handles the network settings.

To view the **Network Settings** screen, click **System Setup Main Menu** → **System BIOS** → **Network Settings**.

The **Network Settings** screen details are explained as follows:

Option	Description
<b>PXE Device n (n = 1 to 4)</b>	Enables or disables the device. When enabled, a UEFI boot option is created for the device.
<b>PXE Device n Settings (n = 1 to 4)</b>	Enables you to control the configuration of the PXE device.

## UEFI iSCSI Settings screen details

You can use the iSCSI Settings screen to modify iSCSI device settings. The iSCSI Settings option is available only in the UEFI boot mode. BIOS does not control network settings in the BIOS boot mode. For BIOS boot mode, the option ROM of the network controller handles the network settings.

To view the **UEFI iSCSI Settings** screen, click **System Setup Main Menu** → **System BIOS** → **Network Settings** → **UEFI iSCSI Settings**.

The **UEFI iSCSI Settings** screen details are explained as follows:

Option	Description
<b>iSCSI Initiator Name</b>	Specifies the name of the iSCSI initiator (iqn format).
<b>iSCSI Device n (n = 1 to 4)</b>	Enables or disables the iSCSI device. When disabled, a UEFI boot option is created for the iSCSI device automatically.



## Integrated Devices screen details

You can use the **Integrated Devices** screen to view and configure the settings of all integrated devices including the video controller, integrated RAID controller, and the USB ports.

To view the **Integrated Devices** screen, click **System Setup Main Menu** → **System BIOS** → **Integrated Devices**.

The **Integrated Devices** screen details are explained as follows:

Option	Description
<b>User Accessible USB Ports</b>	Enables or disables the USB ports. Selecting <b>Only Back Ports On</b> disables the front USB ports, selecting <b>All Ports Off</b> disables all USB ports. The USB keyboard and mouse operates during boot process in certain operating systems. After the boot process is complete, the USB keyboard and mouse do not work if the ports are disabled.





Option	Description
	 <b>NOTE:</b> Selecting <b>Only Back Ports On</b> and <b>All Ports Off</b> disables the USB management port and also restricts access to iDRAC features.
<b>Internal USB Port</b>	Enables or disables the internal USB port. This option is set to <b>Enabled</b> by default.
<b>Integrated Network Card 1</b>	Enables or disables the integrated network card.
<b>Embedded NIC1 and NIC2</b>	 <b>NOTE:</b> The Embedded NIC1 and NIC2 options are only available on systems that do not have <b>Integrated Network Card 1</b> .  Enables or disables the Embedded NIC1 and NIC2 options. If set to <b>Disabled</b> , the NIC may still be available for shared network access by the embedded management controller. The embedded NIC1 and NIC2 options are only available on systems that do not have Network Daughter Cards (NDCs). This option is mutually exclusive with the Integrated Network Card 1 option. Configure this function by using the NIC management utilities of the system.
<b>Embedded Video Controller</b>	Allows you to enable or disable the <b>Embedded Video Controller</b> option. This option is set to <b>Enabled</b> by default.
<b>Current State of Embedded Video Controller</b>	Displays the current state of the embedded video controller. The <b>Current State of Embedded Video Controller</b> option is a read-only field. If the <b>Embedded Video Controller</b> is the only display capability in the system (that is, no add-in graphics card is installed), then the <b>Embedded Video Controller</b> is automatically used as the primary display even if the <b>Embedded Video Controller</b> setting is set to <b>Disabled</b> .
<b>OS Watchdog Timer</b>	If your system stops responding, this watchdog timer aids in the recovery of your operating system. When this option is set to <b>Enabled</b> , the operating system initializes the timer. When this option is set to <b>Disabled</b> (the default), the timer does not have any effect on the system.
<b>Memory Mapped I/O above 4 GB</b>	Enables or disables the support for PCIe devices that require large amounts of memory. This option is set to <b>Enabled</b> by default.
<b>Slot Disablement</b>	Enables or disables the available PCIe slots on your system. The slot disablement feature controls the configuration of PCIe cards installed in the specified slot. Slot disablement must be used only when the installed peripheral card prevents booting into the operating system or causes delays in system startup. If the slot is disabled, both the Option ROM and UEFI drivers are disabled.

## Serial Communication screen details

You can use the **Serial Communication** screen to view the properties of the serial communication port. To view the **Serial Communication** screen, click **System Setup Main Menu** → **System BIOS** → **Serial Communication**.

The **Serial Communication** screen details are explained as follows:

Option	Description
<b>Serial Communication</b>	Selects serial communication devices (Serial Device 1 and Serial Device 2) in BIOS. BIOS console redirection can also be enabled and the port address can be specified. This option is set to <b>Auto</b> by default.
<b>Serial Port Address</b>	Enables you to set the port address for serial devices. This option is set to <b>Serial Device 1=COM2, Serial Device 2=COM1</b> by default.

Option	Description
	<p> <b>NOTE:</b> You can use only Serial Device 2 for the Serial Over LAN (SOL) feature. To use console redirection by SOL, configure the same port address for console redirection and the serial device.</p> <p> <b>NOTE:</b> Every time the system boots, the BIOS syncs the serial MUX setting saved in iDRAC. The serial MUX setting can independently be changed in iDRAC. Loading the BIOS default settings from within the BIOS setup utility may not always revert the serial MUX setting to the default setting of Serial Device 1.</p>
<b>External Serial Connector</b>	<p>Enables you to associate the External Serial Connector to Serial Device 1, Serial Device 2, or the Remote Access Device by using this field.</p> <p> <b>NOTE:</b> Only Serial Device 2 can be used for Serial Over LAN (SOL). To use console redirection by SOL, configure the same port address for console redirection and the serial device.</p> <p> <b>NOTE:</b> Every time the system boots, the BIOS syncs the serial MUX setting saved in iDRAC. The serial MUX setting can independently be changed in iDRAC. Loading the BIOS default settings from within the BIOS setup utility may not always revert this setting to the default setting of Serial Device 1.</p>
<b>Failsafe Baud Rate</b>	<p>Displays the failsafe baud rate for console redirection. The BIOS attempts to determine the baud rate automatically. This failsafe baud rate is used only if the attempt fails, and the value must not be changed. This option is set to <b>115200</b> by default.</p>
<b>Remote Terminal Type</b>	<p>Sets the remote console terminal type. This option is set to <b>VT 100/VT 220</b> by default.</p>
<b>Redirection After Boot</b>	<p>Enables or disables the BIOS console redirection when the operating system is loaded. This option is set to <b>Enabled</b> by default.</p>



## System Profile Settings screen details

You can use the **System Profile Settings** screen to enable specific system performance settings such as power management.

To view the **System Profile Settings** screen, click **System Setup Main Menu** → **System BIOS** → **System Profile Settings**.

The **System Profile Settings** screen details are explained as follows:

Option	Description
<b>System Profile</b>	<p>Sets the system profile. If you set the <b>System Profile</b> option to a mode other than <b>Custom</b>, the BIOS automatically sets the rest of the options. You can only change the rest of the options if the mode is set to <b>Custom</b>. This option is set to <b>Performance Per Watt (OS)</b>.</p> <p> <b>NOTE:</b> All the parameters on the system profile setting screen available only when the <b>System Profile</b> option is set to <b>Custom</b>.</p>
<b>CPU Power Management</b>	<p>Sets the CPU power management. This option is set to <b>OS DBPM</b> by default. DBPM is Demand-Based Power Management.</p>

Option	Description
<b>Memory Frequency</b>	Sets the speed of the system memory. You can select <b>Maximum Performance</b> , <b>Maximum Reliability</b> , or a specific speed.
<b>Turbo Boost</b>	Enables or disables the processor to operate in turbo boost mode. This option is set to <b>Enabled</b> by default.
<b>C1E</b>	Enables or disables the processor to switch to a minimum performance state when it is idle. This option is set to <b>Enabled</b> by default.
<b>C States</b>	Enables or disables the processor to operate in all available power states. This option is set to <b>Enabled</b> by default.
<b>Memory Refresh Rate</b>	Sets the memory refresh rate to either 1x or 2x. This option is set to <b>1x</b> by default.
<b>Uncore Frequency</b>	Enables you to select the <b>Processor Uncore Frequency</b> . Dynamic mode enables the processor to optimize power resources across the cores and uncore during runtime. The optimization of the uncore frequency to either save power or optimize performance is influenced by the setting of the <b>Energy Efficiency Policy</b> .
<b>Energy Efficient Policy</b>	Enables you to select the <b>Energy Efficient Policy</b> . The CPU uses the setting to manipulate the internal behavior of the processor and determines whether to target higher performance or better power savings.
<b>Number of Turbo Boot Enabled Cores for Processor 1</b>	Controls the number of turbo boost enabled cores for processor 1. The maximum number of cores is enabled by default.
<b>Monitor/Mwait</b>	Enables the Monitor/Mwait instructions in the processor. This option is set to <b>Enabled</b> for all system profiles, except <b>Custom</b> by default.   <b>NOTE:</b> This option can be disabled only if the <b>C States</b> option in the <b>Custom</b> mode is set to <b>disabled</b> .   <b>NOTE:</b> When <b>C States</b> is set to <b>Enabled</b> in the <b>Custom</b> mode, changing the Monitor/Mwait setting does not impact the system power or performance.



## System Security Settings screen details

You can use the **System Security** screen to perform specific functions such as setting the system password, setup password and disabling the power button.

To view the **System Security** screen, click **System Setup Main Menu** → **System BIOS** → **System Security Settings**.

The **System Security Settings** screen details are explained as follows:

Option	Description
<b>Intel AES-NI</b>	Improves the speed of applications by performing encryption and decryption by using the Advanced Encryption Standard Instruction Set (AES-NI) and is set to <b>Enabled</b> by default.

Option	Description
<b>System Password</b>	Sets the system password. This option is set to <b>Enabled</b> by default and is read-only if the password jumper is not installed in the system.
<b>Setup Password</b>	Sets the setup password. This option is read-only if the password jumper is not installed in the system.
<b>Password Status</b>	Locks the system password. This option is set to <b>Unlocked</b> by default.
<b>TPM Security</b>	 <b>NOTE:</b> The TPM menu is available only when the TPM module is installed. Enables you to control the reporting mode of the TPM. The <b>TPM Security</b> option is set to <b>Off</b> by default. You can only modify the TPM Status, TPM Activation, and Intel TXT fields if the <b>TPM Status</b> field is set to either <b>On with Pre-boot Measurements</b> or <b>On without Pre-boot Measurements</b> .
<b>TPM Information</b>	Changes the operational state of the TPM. This option is set to <b>No Change</b> by default.
<b>TPM Status</b>	Displays the TPM status.
<b>TPM Command</b>	 <b>CAUTION: Clearing the TPM results in the loss of all keys in the TPM. The loss of TPM keys may affect booting to the operating system.</b> Clears all the contents of the TPM. The <b>TPM Clear</b> option is set to <b>No</b> by default.
<b>Intel TXT</b>	Enables or disables the Intel Trusted Execution Technology (TXT) option. To enable the <b>Intel TXT</b> option, virtualization technology and TPM Security must be enabled with Pre-boot measurements. This option is set to <b>Off</b> by default.
<b>Power Button</b>	Enables or disables the power button on the front of the system. This option is set to <b>Enabled</b> by default.
<b>NMI Button</b>	Enables or disables the NMI button on the front of the system. This option is set to <b>Disabled</b> by default.
<b>AC Power Recovery</b>	Sets how the system behaves after AC power is restored to the system. This option is set to <b>Last</b> by default.
<b>AC Power Recovery Delay</b>	Sets the time delay for system power up after AC power is restored to the system. This option is set to <b>Immediate</b> by default.
<b>User Defined Delay (60s to 240s)</b>	Sets the <b>User Defined Delay</b> option when the <b>User Defined</b> option for <b>AC Power Recovery Delay</b> is selected.
<b>UEFI Variable Access</b>	Provides varying degrees of securing UEFI variables. When set to <b>Standard</b> (the default), UEFI variables are accessible in the operating system per the UEFI specification. When set to <b>Controlled</b> , selected UEFI variables are protected in the environment and new UEFI boot entries are forced to be at the end of the current boot order.
<b>Secure Boot</b>	Enables Secure Boot, where the BIOS authenticates each pre-boot image by using the certificates in the Secure Boot Policy. Secure Boot is disabled by default.
<b>Secure Boot Policy</b>	When Secure Boot policy is set to <b>Standard</b> , the BIOS uses the system manufacturer's key and certificates to authenticate pre-boot images. When Secure Boot policy is set to <b>Custom</b> , the BIOS uses the user-defined key and certificates. Secure Boot policy is set to <b>Standard</b> by default.

Option	Description
<b>Secure Boot Policy Summary</b>	Displays the list of certificates and hashes that secure boot uses to authenticate images.

### Secure Boot Custom Policy Settings screen details

Secure Boot Custom Policy Settings is displayed only when the **Secure Boot Policy** option is set to **Custom**.

To view the **Secure Boot Custom Policy Settings** screen, click **System Setup Main Menu** → **System BIOS** → **System Security** → **Secure Boot Custom Policy Settings**.

The **Secure Boot Custom Policy Settings** screen details are explained as follows:

Option	Description
<b>Platform Key</b>	Imports, exports, deletes, or restores the platform key (PK).
<b>Key Exchange Key Database</b>	Enables you to import, export, delete, or restore entries in the Key Exchange Key (KEK) Database.
<b>Authorized Signature Database</b>	Imports, exports, deletes, or restores entries in the Authorized Signature Database (db).
<b>Forbidden Signature Database</b>	Imports, exports, deletes, or restores entries in the Forbidden Signature Database (dbx).

### Miscellaneous Settings screen details

You can use the **Miscellaneous Settings** screen to perform specific functions such as updating the asset tag and changing the system date and time.

To view the **Miscellaneous Settings** screen, click **System Setup Main Menu** → **System BIOS** → **Miscellaneous Settings**.

The **Miscellaneous Settings** screen details are explained as follows:

Option	Description
<b>System Time</b>	Enables you to set the time on the system.
<b>System Date</b>	Enables you to set the date on the system.
<b>Asset Tag</b>	Displays the asset tag and enables you to modify it for security and tracking purposes.
<b>Keyboard NumLock</b>	Enables you to set whether the system boots with the NumLock enabled or disabled. This option is set to <b>On</b> by default.  <b>NOTE:</b> This option does not apply to 84-key keyboards.
<b>F1/F2 Prompt on Error</b>	Enables or disables the F1/F2 prompt on error. This option is set to <b>Enabled</b> by default. The F1/F2 prompt also includes keyboard errors.
<b>Load Legacy Video Option ROM</b>	Enables you to determine whether the system BIOS loads the legacy video (INT 10H) option ROM from the video controller. Selecting <b>Enabled</b> in the operating system does not support UEFI video output standards. This field is available only for UEFI boot mode. You cannot set the option to <b>Enabled</b> if <b>UEFI Secure Boot</b> mode is enabled.



# About Boot Manager

Boot manager enables you to add, delete, and arrange boot options. You can also access System Setup and boot options without restarting the system.

## Entering Boot Manager

The boot manager screen enables you to select boot options and diagnostic utilities.

1. Turn on, or restart your system.
2. Press F11 when you see the message `F11 = Boot Manager`.  
If your operating system begins to load before you press F11, allow the system to complete the booting, and then restart your system and try again.

## Boot Manager main menu

Menu item	Description
<b>Continue Normal Boot</b>	The system attempts to boot to devices starting with the first item in the boot order. If the boot attempt fails, the system continues with the next item in the boot order until the boot is successful or no more boot options are found.
<b>One Shot Boot Menu</b>	Takes you to the boot menu, where you can select a one time boot device to boot from.
<b>Launch System Setup</b>	Enables you to access System Setup.
<b>Launch Lifecycle Controller</b>	Exits the Boot Manager and invokes the Dell Lifecycle Controller program.
<b>System Utilities</b>	Launches System Utilities menu such as System Diagnostics and UEFI shell.

# About Dell Lifecycle Controller

Dell Lifecycle Controller enables you to perform tasks such as configuring BIOS and hardware settings, deploying an operating system, updating drivers, changing RAID settings, and saving hardware profiles. For more information about Dell Lifecycle Controller, see the documentation at [Dell.com/idracmanuals](http://Dell.com/idracmanuals).

## Changing the boot order

You may have to change the boot order if you want to boot from a USB key or an optical drive. The following instructions may vary if you have selected **BIOS** for **Boot Mode**.

1. On the **System Setup Main Menu** screen, click **System BIOS** → **Boot Settings**.
2. Click **Boot Option Settings** → **Boot Sequence**.
3. Use the arrow keys to select a boot device, and use the plus (+) and minus (-) sign keys to move the device down or up in the order.
4. Click **Exit**, and then click **Yes** to save the settings on exit.

## Choosing the system boot mode

System Setup enables you to specify one of the following boot modes for installing your operating system:

- BIOS boot mode (the default) is the standard BIOS-level boot interface.
  - Unified Extensible Firmware Interface (UEFI) boot mode is an enhanced 64-bit boot interface. If you have configured your system to boot to UEFI mode, it overlays the system BIOS.
1. From the **System Setup Main Menu**, click **Boot Settings** and select **Boot Mode**.
  2. Select the boot mode you want the system to boot into.

 **CAUTION: Switching the boot mode may prevent the system from booting if the operating system is not installed in the same boot mode.**

3. After the system boots in the specified boot mode, proceed to install your operating system from that mode.

 **NOTE:** Operating systems must be UEFI-compatible to be installed from the UEFI boot mode. DOS and 32-bit operating systems do not support UEFI and can only be installed from the BIOS boot mode.

 **NOTE:** For the latest information about supported operating systems, go to [Dell.com/ossupport](https://Dell.com/ossupport).

## Creating a system or setup password

### Prerequisites

- Ensure that the password jumper setting is enabled. The password jumper enables or disables the system password and setup password features. For more information about the password jumper settings, see [System board jumpers and connectors](#).
- Ensure that password status is unlocked in the **System Security Settings** screen. For more information, see [System Security Settings screen details](#).

 **NOTE:** If the password jumper setting is disabled, the existing system password and setup password are deleted and you need not provide the system password to boot the system.

### Steps

1. To enter system setup, press F2 immediately after turning on or restarting the system.
2. On the **System Setup Main Menu** screen, click **System BIOS** → **System Security**.
3. On the **System Security** screen, verify that **Password Status** is set to **Unlocked**.
4. In the **System Password** field, type your system password, and then press Enter or Tab.

Use the following guidelines to assign the system password:

- A password can have up to 32 characters.
- The password can contain the numbers 0 through 9.
- Only the following special characters are allowed: space, ("), (+), (,), (-), (.), (/), (:), (|), (\), (|), (').

A message prompts you to reenter the system password.

5. Reenter the system password, and click **OK**.
6. In the **Setup Password** field, type your system password, and then press Enter or Tab.  
A message prompts you to reenter the setup password.
7. Reenter the setup password, and click **OK**.

8. Press Esc to return to the **System BIOS** screen. Press Esc again.  
A message prompts you to save the changes.

 **NOTE:** Password protection does not take effect until the system reboots.

## Using your system password to secure your system

### About this task

If you have assigned a setup password, the system accepts your setup password as an alternate system password.

### Steps

1. Turn on or reboot your system.
2. Type your system password and press Enter.

### Next steps

When **Password Status** is set to **Locked**, type the password and press Enter when prompted at reboot.

 **NOTE:** If an incorrect system password is typed, the system displays a message and prompts you to reenter your password. You have three attempts to type the correct password. After the third unsuccessful attempt, the system displays an error message that the system stops functioning and must be turned off.

Even after you turn off and restart the system, the error message is displayed until the correct password is entered.

## Deleting or changing system password and setup password

### Prerequisites

Ensure that the password jumper is **Enabled** and the **Password Status** is set to **Unlocked** before attempting to delete or change the existing system or setup password.

 **NOTE:** You cannot delete or change an existing system or setup password if the **Password Status** is set to **Locked**.

### Steps

1. To enter System Setup, press F2 immediately after a turning on or restarting your system.
2. On the **System Setup Main Menu** screen, click **System BIOS** → **System Security**.
3. On the **System Security** screen, verify that **Password Status** is set to **Unlocked**.
4. In the **System Password** field, alter or delete the existing system password, and then press Enter or Tab.
5. In the **Setup Password** field, alter or delete the existing setup password, and then press Enter or Tab.  
If you change the system and setup password a message prompts you to reenter the new password.  
If you delete the system and setup password, a message prompts you to confirm the deletion.
6. Press Esc to return to the **System BIOS** screen. Press Esc again, and a message prompts you to save the changes.

## Operating with a setup password enabled

If **Setup Password** is set to **Enabled**, type the correct setup password before modifying the system setup options.

If you do not type the correct password in three attempts, the system displays the following message:

```
Invalid Password! Number of unsuccessful password attempts: <x> System Halted!  
Must power down.
```

Even after you turn off and restart the system, the error message is displayed until the correct password is typed. The following options are exceptions:

- If **System Password** is not set to **Enabled** and is not locked through the **Password Status** option, you can assign a system password. For more information, see System Security Settings screen.
- You cannot disable or change an existing system password.

 **NOTE:** You can use the password status option with the setup password option to protect the system password from unauthorized changes.

## Embedded system management

The Dell Lifecycle Controller provides advanced embedded systems management throughout the server's lifecycle. The Dell Lifecycle Controller can be started during the boot sequence and can function independently of the operating system.

 **NOTE:** Certain platform configurations may not support the full set of features provided by the Dell Lifecycle Controller.

For more information about setting up the Dell Lifecycle Controller, configuring hardware and firmware, and deploying the operating system, see the Dell Lifecycle Controller documentation at [Dell.com/idracmanuals](https://www.dell.com/support/manuals).

## iDRAC Settings utility

The iDRAC settings utility is an interface to set up and configure the iDRAC parameters by using UEFI. You can enable or disable various iDRAC parameters by using the iDRAC settings utility.

 **NOTE:** Accessing some of the features on the iDRAC settings utility requires the iDRAC Enterprise License upgrade.

For more information about using iDRAC, see *iDRAC User's Guide* at [Dell.com/idracmanuals](https://www.dell.com/support/manuals).

### Entering the iDRAC settings utility

1. Turn on or restart the managed system.
2. Press F2 during Power-on Self-test (POST).
3. On the **System Setup Main Menu** page, click **iDRAC Settings**.  
The **iDRAC Settings** screen is displayed.







## Changing the thermal settings

The iDRAC settings utility enables you to select and customize the thermal control settings for your system.

1. Click **iDRAC Settings** → **Thermal**.
2. Under **SYSTEM THERMAL PROFILE** → **Thermal Profile**, select one of the following options:
  - Default Thermal Profile Settings
  - Maximum Performance (Performance Optimized)
  - Minimum Power (Performance per Watt Optimized)
3. Under **USER COOLING OPTIONS**, set the **Fan Speed Offset**, **Minimum Fan Speed**, and **Custom Minimum Fan Speed**.
4. Click **Back** → **Finish** → **Yes**.

# Installing and removing system components

## Safety instructions

-  **WARNING:** Whenever you need to lift the system, get others to assist you. To avoid injury, do not attempt to lift the system by yourself.
-  **WARNING:** Opening or removing the system cover while the system is powered on may expose you to a risk of electric shock.
-  **CAUTION:** Do not operate the system without the cover for a duration exceeding five minutes.
-  **CAUTION:** Many repairs may only be done by a certified service technician. You should only perform troubleshooting and simple repairs as authorized in your product documentation, or as directed by the online or telephone service and support team. Damage due to servicing that is not authorized by Dell is not covered by your warranty. Read and follow the safety instructions that came with the product.
-  **NOTE:** Dell recommends that you always use a static mat and static strap while working on components inside the system.
-  **NOTE:** To ensure proper operation and cooling, all bays in the system must be populated always with either a component or with a blank.

## Before working inside your system

### Prerequisites

Ensure that you follow the [Safety instructions](#).

### Steps

1. Turn off the system and any attached peripherals.
2. Disconnect the system from the electrical outlet and disconnect the peripherals.
3. Lay the system on its side.
4. Remove the system cover.

### Related Tasks

[Removing the system cover](#)

## After working inside your system

1. Install the system cover.
2. Place the system upright on its feet on a flat and stable surface.
3. Reconnect the peripherals and connect the system to the electrical outlet.

4. Turn on the system, including any attached peripherals.

**Related Tasks**

[Installing the system cover](#)

## Recommended tools

You need the following tools to perform the installation and removal procedures:

- Phillips #2 screwdriver
- Plastic scribe
- Wrist grounding strap connected to ground

## System cover

### Removing the system cover

**Prerequisites**

1. Ensure that you follow the [Safety instructions](#).
2. Turn off the system and any attached peripherals.
3. Disconnect the system from the electrical outlet and disconnect the peripherals.
4. Lay the system on its side.

**Steps**

Lift the cover release latch and remove the cover away from the system.

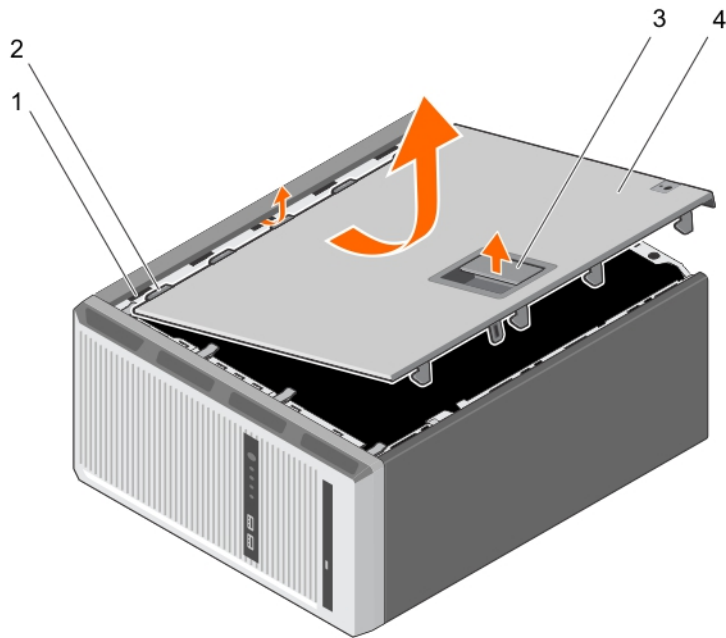

**Figure 5. Removing and installing the system cover**

- |                        |                 |
|------------------------|-----------------|
| 1. slots               | 2. tabs         |
| 3. cover release latch | 4. system cover |

#### **Next steps**

1. Install the system cover.
2. Place the system upright on its feet on a flat and stable surface.
3. Reconnect the peripherals and connect the system to the electrical outlet.
4. Turn the system on, including any attached peripherals.

#### **Related Tasks**

[Installing the system cover](#)

## **Installing the system cover**

#### **Prerequisites**

1. Ensure that you follow the [Safety instructions](#).
2. Follow the procedure listed in [Before working inside your system](#).
3. Ensure that all internal cables are connected and placed out of the way and that no tools or extra parts are left inside the system.

#### **Steps**

1. Align the tabs on the system cover with the corresponding slots on the system chassis.
2. Lower the system cover onto the chassis until it clicks into place.



### Next steps

1. Place the system upright on its feet on a flat and stable surface.
2. Reconnect the peripherals and connect the system to the electrical outlet
3. Turn the system on, including any attached peripherals.

## Bezel

### Removing the bezel

#### Prerequisites

1. Ensure that you follow the [Safety instructions](#).
2. Follow the procedure listed in [Before working inside your system](#).

#### Steps

1. Lift the retention clips at the edge of the bezel.
2. Lift the bezel and pull it away from the system.

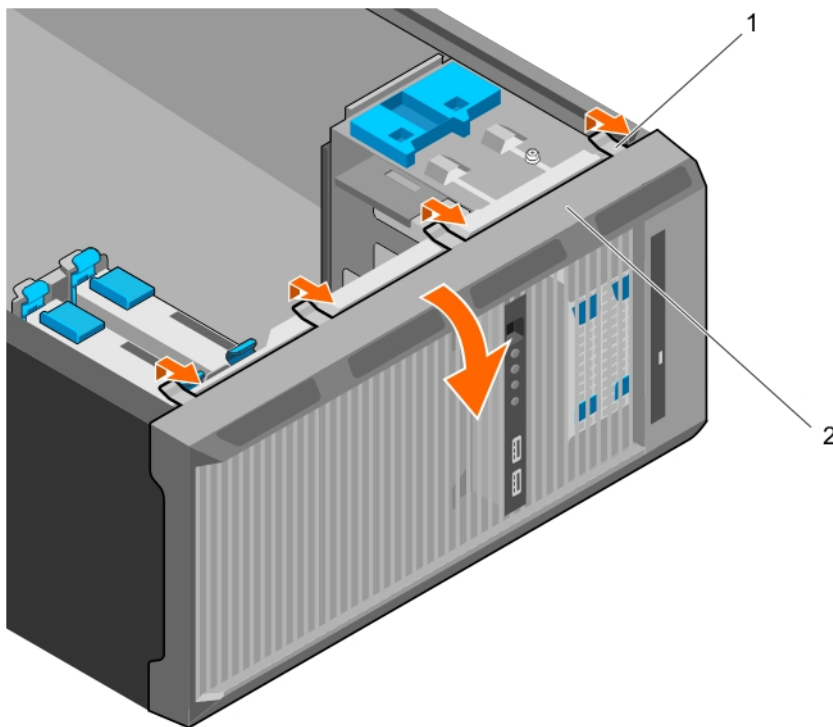

Figure 6. Removing and installing the bezel

1. retention clips (4)

2. bezel

### Next steps

1. Install the bezel.
2. Follow the procedure listed in [After working inside your system](#).

## Related Tasks

[Installing the bezel](#)

## Installing the bezel

### Prerequisites

1. Ensure that you follow the [Safety instructions](#).
2. Follow the procedure listed in [Before working inside your system](#).

### Steps

1. Insert the bezel tabs into the bezel tab slots on the chassis.
2. Press the bezel into the chassis until the retention clips lock into place.

### Next steps

1. Follow the procedure listed in [After working inside your system](#).

## Inside the system

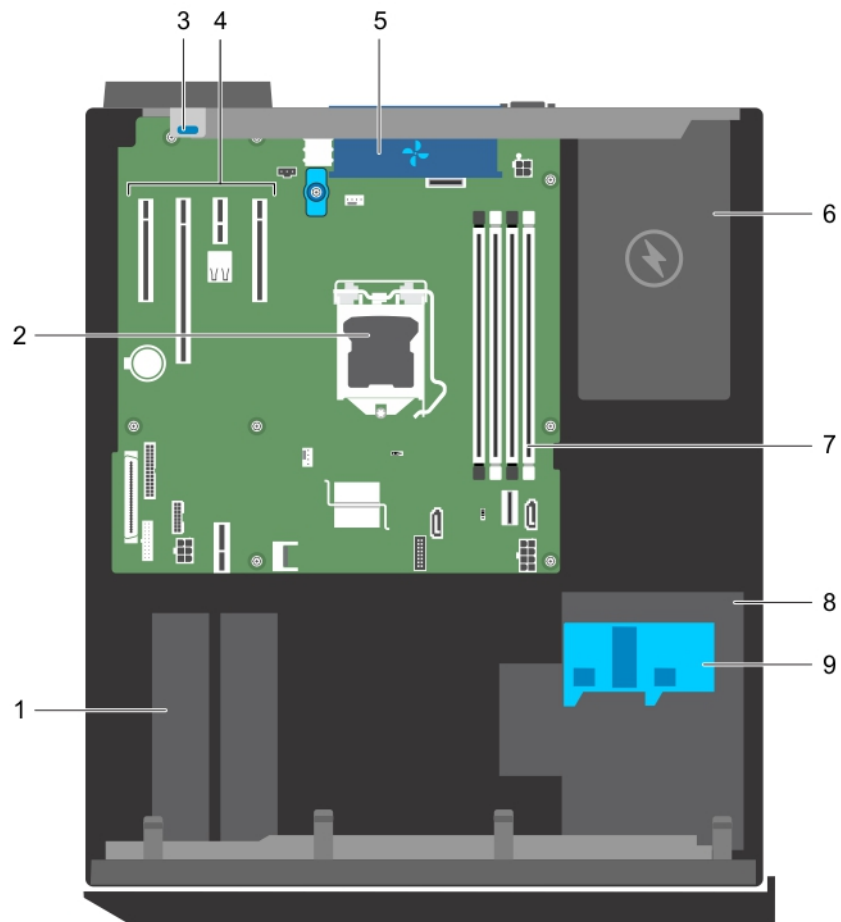

**Figure 7. Inside the system**

- |    |                                |    |                   |
|----|--------------------------------|----|-------------------|
| 1. | hard drive                     | 2. | processor         |
| 3. | expansion card retention latch | 4. | PCIe slots (4)    |
| 5. | system fan                     | 6. | power supply unit |
| 7. | memory slots (4)               | 8. | hard drive cage   |
| 9. | hard drive cage latch          |    |                   |

# Intrusion switch

## Removing the intrusion switch

### Prerequisites

**△ CAUTION:** Many repairs may only be done by a certified service technician. You should only perform troubleshooting and simple repairs as authorized in your product documentation, or as directed by the online or telephone service and support team. Damage due to servicing that is not authorized by Dell is not covered by your warranty. Read and follow the safety instructions that came with the product.

1. Ensure that you follow the [Safety instructions](#).
2. Follow the procedure listed in [Before working inside your system](#).

### Steps

1. Disconnect the intrusion switch cable from the system board.
2. Slide the intrusion switch and push it out of the slot on the chassis.

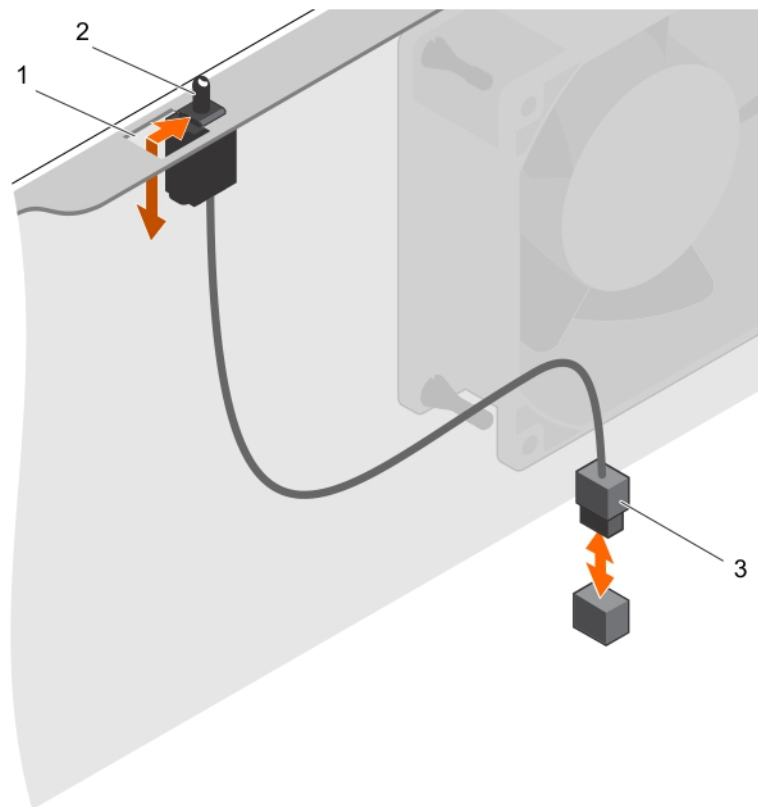

**Figure 8. Removing and installing the intrusion switch**

- |                           |                     |
|---------------------------|---------------------|
| 1. intrusion switch slot  | 2. intrusion switch |
| 3. intrusion switch cable |                     |

### Next steps

1. Install the intrusion switch.
2. Follow the procedure listed in [After working inside your system](#).

### Related Tasks

[Installing the intrusion switch](#)

## Installing the intrusion switch

### Prerequisites

 **CAUTION:** Many repairs may only be done by a certified service technician. You should only perform troubleshooting and simple repairs as authorized in your product documentation, or as directed by the online or telephone service and support team. Damage due to servicing that is not authorized by Dell is not covered by your warranty. Read and follow the safety instructions that came with the product.

1. Ensure that you follow the [Safety instructions](#).
2. Follow the procedure listed in [Before working inside your system](#).

### Steps

1. To install the intrusion switch, insert the intrusion switch into the intrusion switch slot and slide the switch into place.
2. Connect the intrusion switch cable to the system board.

### Next steps

Follow the procedure listed in [After working inside your system](#).

## Control panel assembly

The control panel assembly contains the power button, the diagnostic indicators, and the front USB ports.

## Removing the control panel assembly

### Prerequisites

 **CAUTION:** Many repairs may only be done by a certified service technician. You should only perform troubleshooting and simple repairs as authorized in your product documentation, or as directed by the online or telephone service and support team. Damage due to servicing that is not authorized by Dell is not covered by your warranty. Read and follow the safety instructions that came with the product.

1. Ensure that you follow the [Safety instructions](#).
2. Follow the procedure listed in [Before working inside your system](#).
3. Disconnect all peripherals connected to the control panel assembly.
4. Remove the bezel.
5. Keep the Phillips #2 screwdriver ready.

### Steps

1. Disconnect the control panel and USB data cables from the system board.
2. Remove the screws securing the control panel assembly to the system.

3. Slide the control panel assembly upward to release it.
4. Pull the control panel assembly along with the cables out of the system.

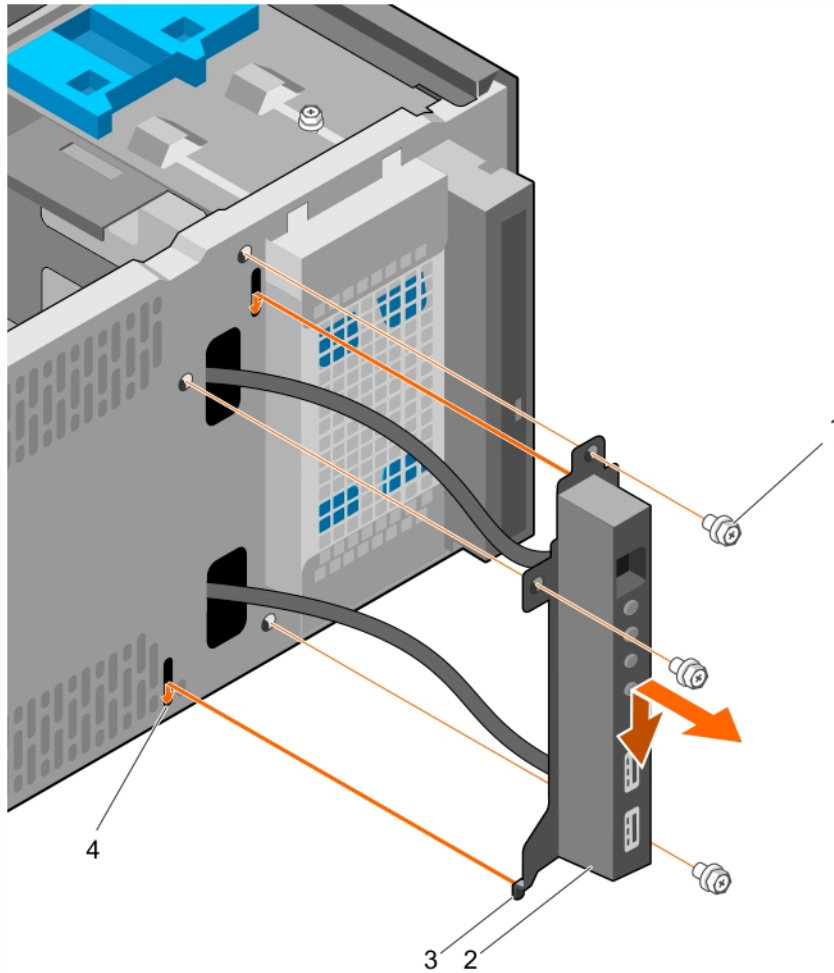

**Figure 9. Removing and installing the control panel assembly**

- |                                     |  |
|-------------------------------------|--|
| 1. screw (3)                        | 2. control panel assembly                |
| 3. control panel assembly guide (2) | 4. control panel assembly guide slot (2) |

#### **Next steps**

1. Install the control panel assembly.
2. Install the bezel.
3. Follow the procedure listed in [After working inside your system](#).

#### **Related Tasks**

[Removing the bezel](#)

[Installing the control panel assembly](#)

[Installing the bezel](#)

## Installing the control panel assembly

### Prerequisites

 **CAUTION:** Many repairs may only be done by a certified service technician. You should only perform troubleshooting and simple repairs as authorized in your product documentation, or as directed by the online or telephone service and support team. Damage due to servicing that is not authorized by Dell is not covered by your warranty. Read and follow the safety instructions that came with the product.

1. Ensure that you follow the [Safety instructions](#).
2. Follow the procedure listed in [Before working inside your system](#).
3. Remove the bezel.
4. Keep the Phillips #2 screwdriver ready.

### Steps

1. Insert the control panel assembly into the guide slot and slide it downward to lock the assembly into place.
2. To secure the control panel, insert and tighten the screws to the chassis.
3. Route the control panel and USB data cables through the chassis clip.
4. Connect the control panel and USB data cables to the system board.

### Next steps

1. Install the bezel.
2. Reconnect the disconnected peripherals from the control panel assembly.
3. Follow the procedure listed in [After working inside your system](#).

### Related Tasks

[Removing the bezel](#)

[Installing the bezel](#)

## Hard drives

 **CAUTION:** Do not turn off or restart your system while the hard drive is being formatted. Doing so can cause a hard drive failure.

 **NOTE:** Do not mix enterprise class hard drives with entry class hard drives.

Your system supports four 3.5-inch entry hard drives and enterprise class hard drives. Entry hard drives are designed for 8x5 operating environment and enterprise class hard drives are designed for 24x7 operating environment. Two hard drives are located in the removable hard drive cage and two hard drives are located in the fixed hard drive bay.

Choosing the right hard drive type depends on the usage pattern. Improper use of entry hard drives (workload rating exceeding 55 TB/year) leads to significant risk and increases the failure rate of the drives. Due to industry advances, in some cases, the larger capacity drives have been changed to a larger sector size. The larger sector size can have impacts on operating systems and applications. For more information about these hard drives, see the *512e and 4Kn Disk Formats* white paper and *4K Sector HDD FAQ* document at [Dell.com/poweredge manuals](http://Dell.com/poweredge manuals).

All hard drives are connected to the system board through the hard drive backplane. Hard drives are supplied in hot-swappable hard drive carriers that fit in the hard drive slots.

When you format a hard drive, allow enough time for the formatting to be complete. Be aware that high-capacity hard drives can take a long time to format.

## Removing the hard drive cage

### Prerequisites



**CAUTION:** Many repairs may only be done by a certified service technician. You should only perform troubleshooting and simple repairs as authorized in your product documentation, or as directed by the online or telephone service and support team. Damage due to servicing that is not authorized by Dell is not covered by your warranty. Read and follow the safety instructions that came with the product.

1. Ensure that you follow the [Safety instructions](#).
2. Follow the procedure listed in [Before working inside your system](#).
3. Disconnect all peripherals connected to the control panel assembly.
4. Remove the bezel.
5. If connected, disconnect the power and data cables from the hard drives and the optical drive in the hard drive cage.

### Steps

Slide and hold the hard drive cage latch and pull the hard drive cage out of the system.



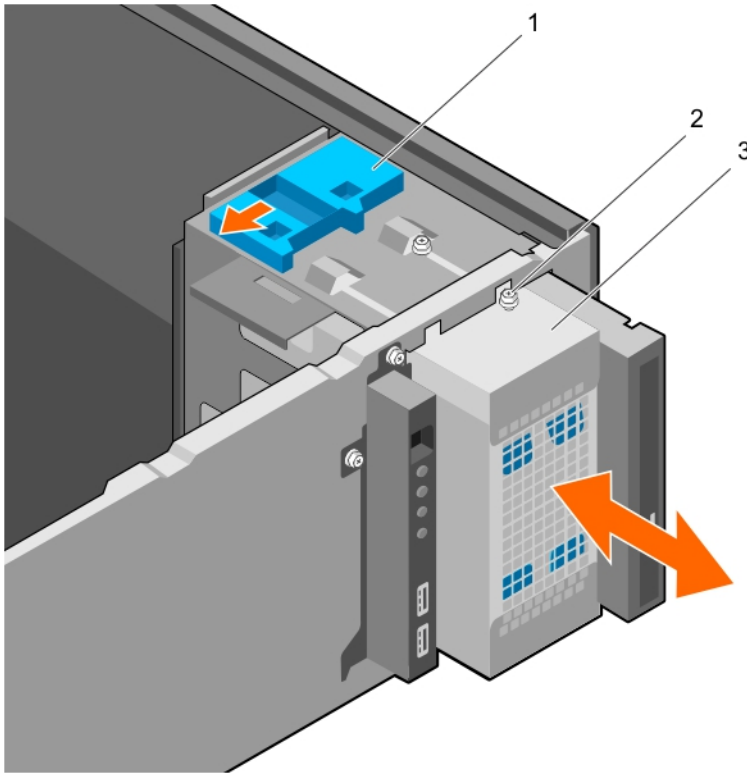

**Figure 10. Removing and installing the hard drive cage**

1. hard drive cage latch
2. hard drive cage guide screw (2)
3. hard drive cage

#### **Next steps**

1. Install the hard drive cage.
2. If disconnected, connect the power and data cables to the hard drives and the optical drive in the hard drive cage.
3. Install the bezel.
4. Reconnect the peripherals disconnected from the control panel assembly.
5. Follow the procedure listed in [After working inside your system](#).

#### **Related Tasks**

[Removing the bezel](#)

[Installing the hard drive cage](#)

[Installing the bezel](#)

## **Installing the hard drive cage**

#### **Prerequisites**

1. Ensure that you follow the [Safety instructions](#).
2. Follow the procedure listed in [Before working inside your system](#).
3. Disconnect all peripherals connected to the control panel assembly.

4. Remove the bezel.

 **CAUTION:** Many repairs may only be done by a certified service technician. You should only perform troubleshooting and simple repairs as authorized in your product documentation, or as directed by the online or telephone service and support team. Damage due to servicing that is not authorized by Dell is not covered by your warranty. Read and follow the safety instructions that came with the product.

#### Steps

Insert the hard drive cage into the system until it clicks into place.

#### Next steps

1. If disconnected, reconnect the power and data cables to the hard drives and optical drive in the hard drive cage.
2. Install the bezel.
3. Reconnect the peripherals disconnected from the control panel assembly.
4. Follow the procedure listed in [After working inside your system](#).

#### Related Tasks

[Removing the bezel](#)

[Installing the bezel](#)

## Removing a hard drive carrier from the hard drive cage

#### Prerequisites

 **CAUTION:** Many repairs may only be done by a certified service technician. You should only perform troubleshooting and simple repairs as authorized in your product documentation, or as directed by the online or telephone service and support team. Damage due to servicing that is not authorized by Dell is not covered by your warranty. Read and follow the safety instructions that came with the product.

1. Ensure that you follow the [Safety instructions](#).
2. Follow the procedure listed in [Before working inside your system](#).
3. Disconnect all peripherals connected to the control panel assembly.
4. Remove the bezel.
5. Remove the power and data cables from the hard drives and optical drive in the hard drive cage.
6. Remove the hard drive cage.

#### Steps

Press the retention clips inward and pull the hard drive out of the hard drive cage.

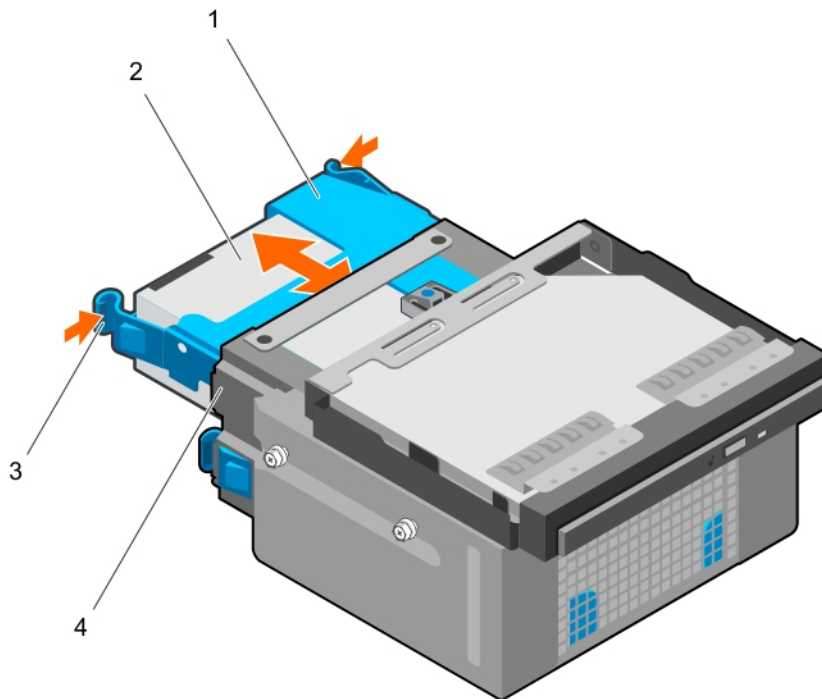

**Figure 11. Removing and installing hard drive carrier from the hard drive cage**

- |                        |                    |
|------------------------|--------------------|
| 1. hard drive carrier  | 2. hard drive      |
| 3. retention clips (2) | 4. hard drive cage |

#### **Next steps**

1. Install the hard drive carrier into the hard drive cage.
2. Install the hard drive cage.
3. Reconnect the power and data cables to the hard drives and optical drive in the hard drive cage.
4. Install the bezel.
5. Reconnect the peripherals disconnected from the control panel assembly.
6. Follow the procedure listed in [After working inside your system](#).

#### **Related Tasks**

[Removing the bezel](#)

[Removing the hard drive cage](#)

[Installing a hard drive carrier into the hard drive cage](#)

[Installing the hard drive cage](#)

[Installing the bezel](#)

## Installing a hard drive carrier into the hard drive cage

### Prerequisites

 **CAUTION:** Many repairs may only be done by a certified service technician. You should only perform troubleshooting and simple repairs as authorized in your product documentation, or as directed by the online or telephone service and support team. Damage due to servicing that is not authorized by Dell is not covered by your warranty. Read and follow the safety instructions that came with the product.

1. Ensure that you follow the [Safety instructions](#).
2. Follow the procedure listed in [Before working inside your system](#).
3. Disconnect all peripherals connected to the control panel assembly.
4. Remove the bezel.
5. Remove the power and data cables from the hard drives and optical drive in the hard drive cage.
6. Remove the hard drive cage.

### Steps

Insert the hard drive carrier into the hard drive cage until it clicks into place.

### Next steps

1. Install the hard drive cage.
2. Reconnect the power and data cables to the hard drives and optical drive in the hard drive cage.
3. Install the bezel.
4. Reconnect the peripherals disconnected from the control panel assembly.
5. Follow the procedure listed in [After working inside your system](#).

### Related Tasks

- [Removing the bezel](#)
- [Removing the hard drive cage](#)
- [Installing the hard drive cage](#)
- [Installing the bezel](#)

## Removing a hard drive carrier from the hard drive bay

### Prerequisites

 **CAUTION:** Many repairs may only be done by a certified service technician. You should only perform troubleshooting and simple repairs as authorized in your product documentation, or as directed by the online or telephone service and support team. Damage due to servicing that is not authorized by Dell is not covered by your warranty. Read and follow the safety instructions that came with the product.

1. Ensure that you follow the [Safety instructions](#).
2. Follow the procedure listed in [Before working inside your system](#).
3. If connected, disconnect the power and data cables from the hard drive in the hard drive bay.

### Steps

Press the retention clips inward and lift the hard drive carrier from the hard drive bay.

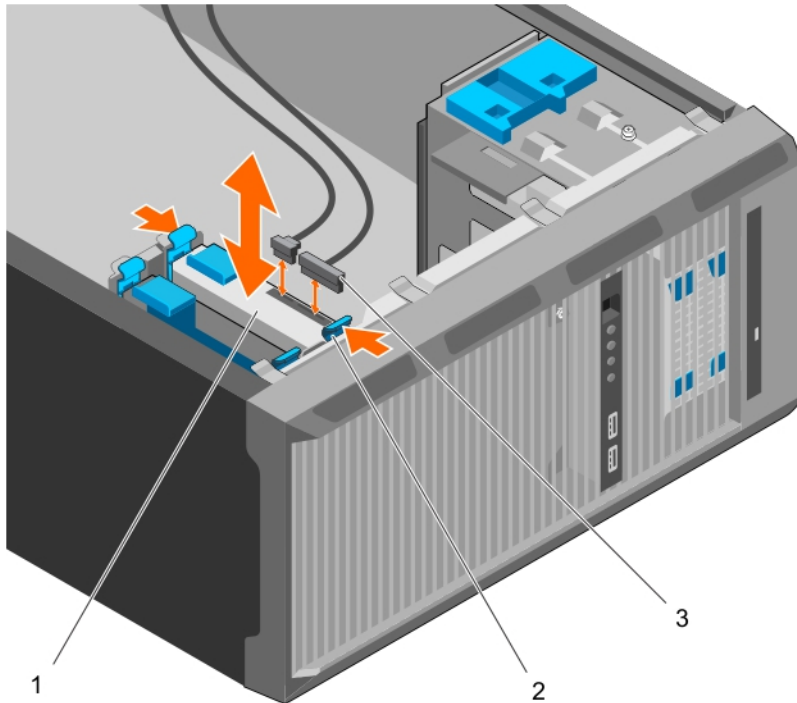

**Figure 12. Removing and installing hard drive carrier from the hard drive bay**

1. hard drive
2. retention clips on hard drive carrier (2)
3. hard drive power and data cables (2)

#### Next steps

1. Install the hard drive carrier into the hard drive bay.
2. If disconnected, connect the power and data cables to the hard drives in the hard drive bay.
3. Follow the procedure listed in [After working inside your system](#).

#### Related Tasks

[Installing a hard drive carrier into the hard drive bay](#)

## Installing a hard drive carrier into the hard drive bay

#### Prerequisites

**⚠ CAUTION:** Many repairs may only be done by a certified service technician. You should only perform troubleshooting and simple repairs as authorized in your product documentation, or as directed by the online or telephone service and support team. Damage due to servicing that is not authorized by Dell is not covered by your warranty. Read and follow the safety instructions that came with the product.

1. Ensure that you follow the [Safety instructions](#).
2. Follow the procedure listed in [Before working inside your system](#).

## Steps

Insert the hard drive carrier into the hard drive bay until it clicks into place.

## Next steps

1. If disconnected, connect the power and data cables to the hard drive in the hard drive bay.
2. Follow the procedure listed in [After working inside your system](#).

## Removing a hard drive from a hard drive carrier

### Prerequisites

**△ CAUTION:** Many repairs may only be done by a certified service technician. You should only perform troubleshooting and simple repairs as authorized in your product documentation, or as directed by the online or telephone service and support team. Damage due to servicing that is not authorized by Dell is not covered by your warranty. Read and follow the safety instructions that came with the product.

1. Ensure that you follow the [Safety instructions](#).
2. Follow the procedure listed in [Before working inside your system](#).
3. Depending on your requirement, remove the hard drive carrier from the hard drive cage or the hard drive bay.

## Steps

To release the hard drive, flex the sides of the hard drive carrier.

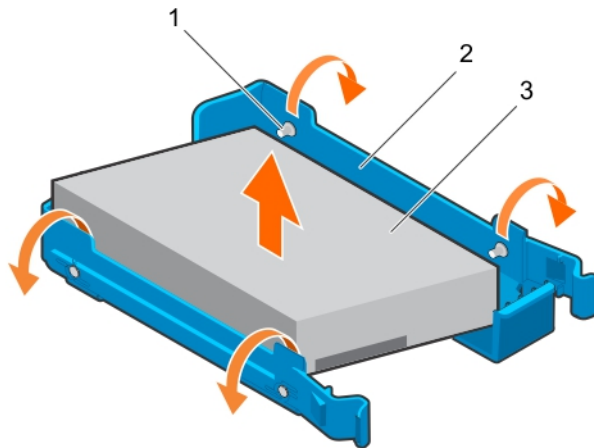

**Figure 13. Removing and installing a hard drive from a hard drive carrier**

1. pins (4)
2. hard drive carrier
3. hard drive

## Next steps

1. Install the hard drive into the hard drive carrier.
2. Follow the procedure listed in [After working inside your system](#).

## Related Tasks

- [Removing a hard drive carrier from the hard drive bay](#)
- [Removing a hard drive carrier from the hard drive cage](#)

## Installing a hard drive into a hard drive carrier

### Prerequisites



**CAUTION:** Many repairs may only be done by a certified service technician. You should only perform troubleshooting and simple repairs as authorized in your product documentation, or as directed by the online or telephone service and support team. Damage due to servicing that is not authorized by Dell is not covered by your warranty. Read and follow the safety instructions that came with the product.

1. Ensure that you follow the [Safety instructions](#).
2. Follow the procedure listed in [Before working inside your system](#).
3. Depending on your requirement, remove the hard drive carrier from the hard drive cage or the hard drive bay.

### Steps

1. Orient the hard drive so that the screw holes on one side of the hard drive align with the pins on the carrier.
2. Flex the other side of the hard drive carrier, and press the hard drive into the hard drive carrier to secure it.

### Next steps

1. Depending on your requirement, install the hard drive carrier in the hard drive cage or the hard drive bay.
2. Follow the procedure listed in [After working inside your system](#).

## Hard drive cabling diagrams

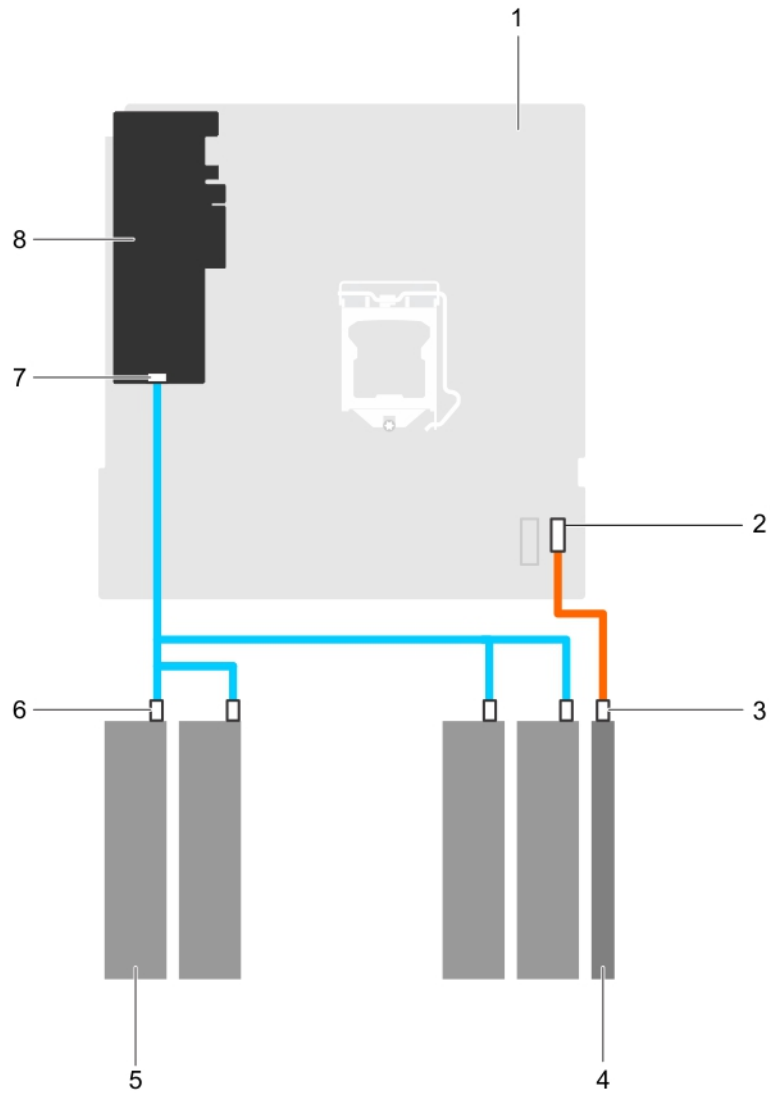

**Figure 14. Cabling diagram for the optical drive and the four 3.5-inch SATA hard drives from the PERC card**

- |                                    |                                   |
|------------------------------------|-----------------------------------|
| 1. system board                    | 2. SATA connector on system board |
| 3. SATA connector on optical drive | 4. optical drive                  |
| 5. hard drive                      | 6. SATA connector on hard drive   |
| 7. SAS A connector on PERC card    | 8. PERC card                      |



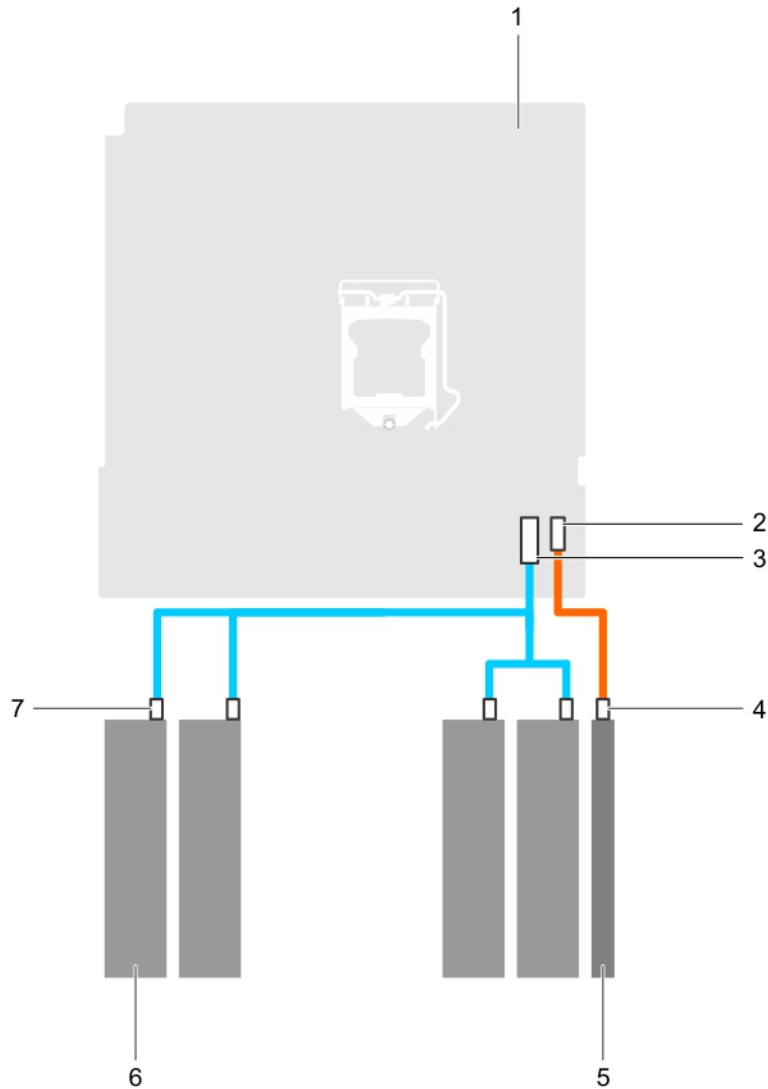

**Figure 15. Cabling diagram for four 3.5-inch SATA hard drive from the system board**

- |                                       |  |
|---------------------------------------|--|
| 1. system board                       | 2. SATA optical drive connector on system board  |
| 3. mini SAS connector on system board | 4. SATA optical drive connector on optical drive |
| 5. optical drive                      | 6. hard drive                                    |
| 7. SATA connector on hard drive       |  |

## Setting the cooling fan speed for 4 TB hard drives

### Prerequisites

**NOTE:** Dell recommends that 4 TB hard drives be used only in systems configured with a PERC controller.

**CAUTION:** Using 4 TB hard drives in the system without a PERC controller might cause hard drive 1 to overheat under excessive work load, leading to a potential failure of the hard drive.

### About this task

When 4 TB hard drives are used in a system without a PERC controller, the speed of the cooling fan needs to be manually adjusted to prevent the hard drives from overheating.

### Steps

1. To enter the iDRAC menu, press F2 or F11 during post.
2. Select iDRAC setting.
3. Select **Thermal** section.
4. Select **Fan Setup** setting.
5. At the **Fan Speed Offset** section, select **Low fan speed offset (+15%)**.

## Optical drive

### Removing the optical drive blank and filler

The optical drive blank is on the bezel and the optical drive filler is located in the optical drive slot on the hard drive cage.

### Prerequisites

1. Ensure that you follow the [Safety instructions](#).
2. Follow the procedure listed in [Before working inside your system](#).
3. Disconnect all peripherals connected to the control panel assembly.
4. Remove the bezel.
5. If connected, disconnect the power and data cable from the optical drive and hard drives.
6. Remove the hard drive cage.

### Steps

1. On the bezel, press down on the retention clip of the optical drive blank and pull the blank out of the bezel.

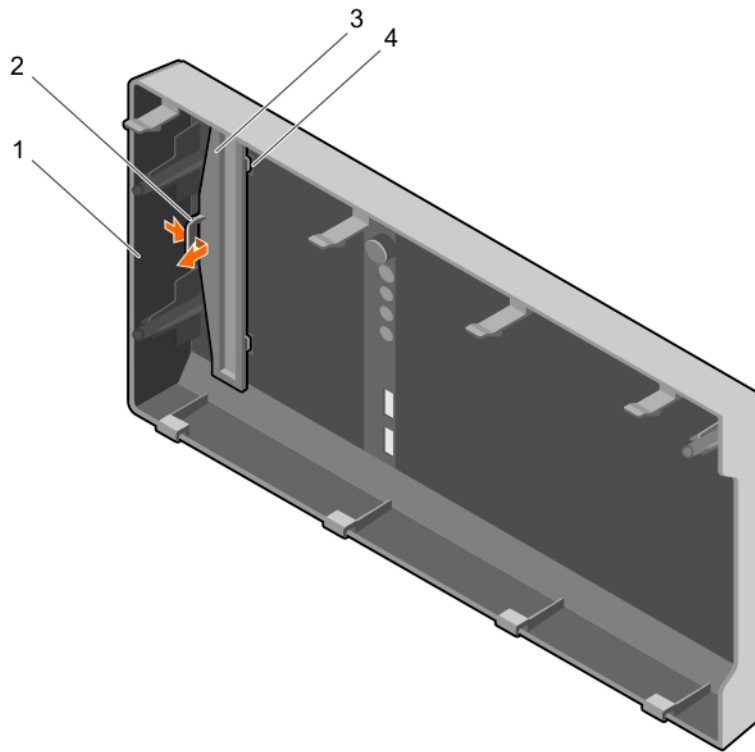

**Figure 16. Removing and installing the optical drive blank from the bezel**

- |                        |  |
|------------------------|--|
| 1. bezel               | 2. retention clip                      |
| 3. optical drive blank | 4. optical drive blank locking tab (2) |
2. On the hard drive cage, hold the tabs on the optical drive filler and remove the optical drive filler from the hard drive cage.

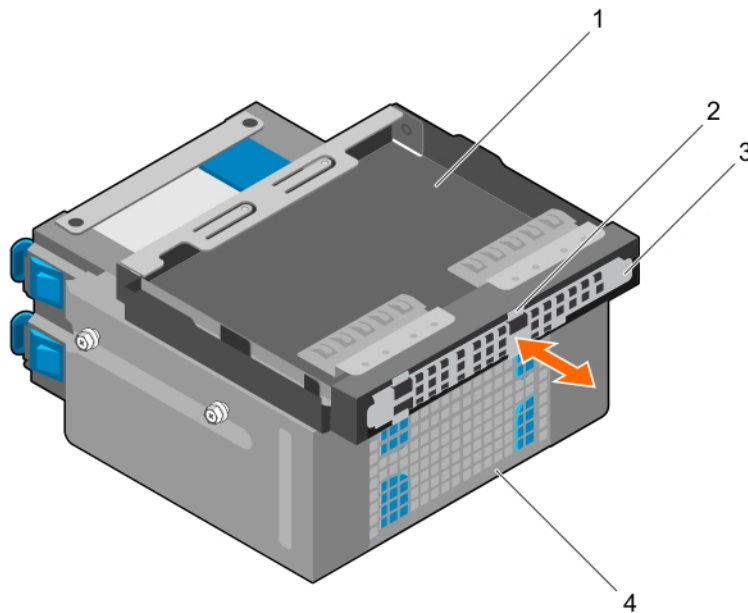

**Figure 17. Removing the optical drive filler**

- |                         |                    |
|-------------------------|--------------------|
| 1. optical drive bay    | 2. tabs (4)        |
| 3. optical drive filler | 4. hard drive cage |

#### Next steps

1. Install the hard drive cage.
2. Reconnect the disconnected data and power cables to the hard drives and optical drive.
3. Install the bezel.
4. Reconnect all peripherals disconnected from the control panel assembly.
5. Follow the procedure listed in [After working inside your system](#).

#### Related Tasks

- [Removing the bezel](#)
- [Removing the hard drive cage](#)
- [Installing the hard drive cage](#)
- [Installing the bezel](#)

## Removing the optical drive

#### Prerequisites

**CAUTION:** Many repairs may only be done by a certified service technician. You should only perform troubleshooting and simple repairs as authorized in your product documentation, or as directed by the online or telephone service and support team. Damage due to servicing that is not authorized by Dell is not covered by your warranty. Read and follow the safety instructions that came with the product.

1. Ensure that you follow the [Safety instructions](#).

2. Follow the procedure listed in [Before working inside your system](#).
3. Disconnect all peripherals connected to the I/O module.
4. Remove the bezel.
5. If connected, disconnect the power and data cables from the optical drive and hard drives.
6. Remove the hard drive cage.

#### Steps

Press down and push the blue release tab and push the optical drive out of the hard drive cage.

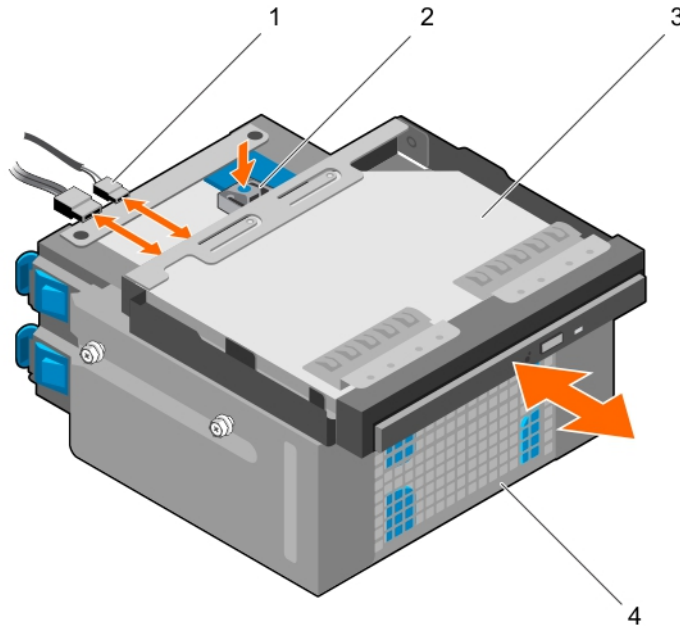

**Figure 18. Removing and installing the optical drive**

- |                         |                    |
|-------------------------|--------------------|
| 1. SATA and power cable | 2. release tab     |
| 3. optical drive        | 4. hard drive cage |

#### Next steps

1. Install the optical drive.
2. Install the hard drive cage.
3. Reconnect the disconnected data and power cables to the hard drives and optical drive.
4. Install the bezel.
5. Reconnect the peripherals disconnected from the control panel assembly.
6. Follow the procedure listed in [After working inside your system](#).

#### Related Tasks

- [Removing the bezel](#)
- [Removing the hard drive cage](#)
- [Installing the optical drive](#)
- [Installing the hard drive cage](#)
- [Installing the bezel](#)

## Installing the optical drive

Only slim 9.5 mm SATA DVD-ROM drive or DVD+/-RW drive can be installed in your system. External optical drives can be connected through USB ports.

### Prerequisites

 **CAUTION:** Many repairs may only be done by a certified service technician. You should only perform troubleshooting and simple repairs as authorized in your product documentation, or as directed by the online or telephone service and support team. Damage due to servicing that is not authorized by Dell is not covered by your warranty. Read and follow the safety instructions that came with the product.

1. Ensure that you follow the [Safety instructions](#).
2. Follow the procedure listed in [Before working inside your system](#).
3. Disconnect all peripherals connected to the I/O module.
4. Remove the bezel.
5. If connected, disconnect the power and data cables from the optical drive and hard drives.
6. Remove the hard drive cage.
7. If installed, remove the optical drive blank from the bezel and the optical drive filler from the hard drive cage.

### Steps

1. Align the optical drive with the optical drive slot on the front of the chassis.
2. Slide the optical drive into the slot until the release tab locks into place.
3. Connect the power and data cables to the optical drive.
4. Route the power and data cables through the cable routing guides on the system chassis.

### Next steps

1. Install the hard drive cage.
2. If disconnected, reconnect the disconnected data and power cables to the hard drives and optical drive.
3. Install the bezel.
4. Reconnect the peripherals disconnected from the control panel assembly.
5. Follow the procedure listed in [After working inside your system](#).

### Related Tasks

[Removing the bezel](#)

[Removing the hard drive cage](#)

[Removing the optical drive blank and filler](#)

[Installing the optical drive](#)

[Installing the hard drive cage](#)

[Installing the bezel](#)

## System memory

Your system supports DDR4 ECC unbuffered DIMMs (UDIMMs).

 **NOTE:** MT/s indicates memory module speed in Mega Transfers per second.

Memory bus operating frequency can be 2133 MT/s, 1866 MT/s, or 1600 MT/s depending on the following factors:

- System profile selected (for example, Performance Optimized, Custom, or Dense Configuration Optimized)
- Maximum supported memory module frequency of the processors

The system contains four memory sockets — two sets of 2-sockets each. Each 2-socket set is organized into one channel. In each 2-socket set, the first socket release lever is marked white and the second socket release lever is marked black.

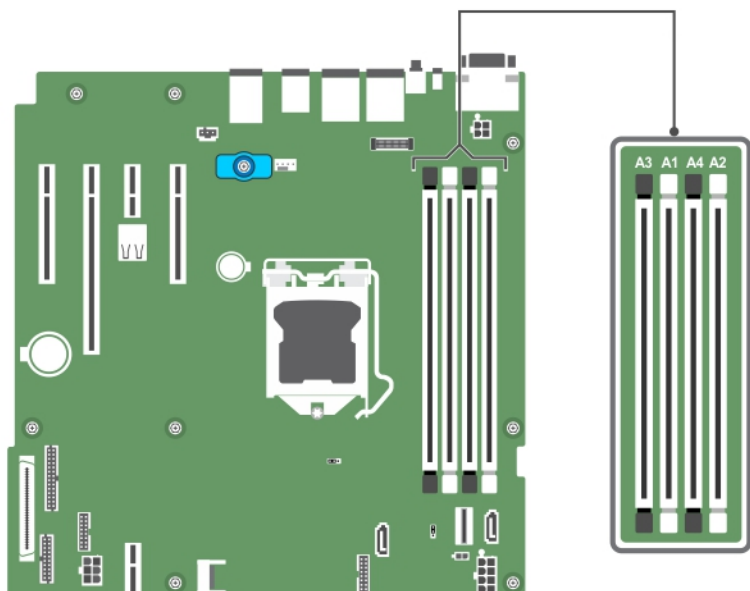

**Figure 19. Memory socket locations on the system board**

Memory channels are organized as follows:

- Processor 1**
- channel 0: memory sockets A1 and A3
  - channel 1: memory sockets A2 and A4

The following table shows the memory populations and operating frequencies for the supported configurations:

**Table 6. Memory populations and operating frequencies for the supported configurations**

Memory module type	Memory modules populated per channel	Operating frequency (in MT/s)	Maximum memory module ranks per channel
<b>1.2 V</b>			
ECC UDIMM	1	2133, 1866, 1600	Dual rank or single rank
	2	2133, 1866, 1600	Dual rank or single rank

## General memory module installation guidelines

Your system supports Flexible Memory Configuration, enabling the system to be configured and run in any valid chipset architectural configuration. The following are the recommended guidelines for installing memory modules:

- x4 and x8 DRAM-based DIMMs can be mixed.
- Up to two dual- or single-rank ECC UDIMMs can be populated per channel.
- Populate DIMM sockets only if a processor is installed. For single-processor systems, sockets A1 to A4 are available.
- Populate all sockets with white release levers first, and then all the sockets with black release levers.
- When mixing memory modules with different capacities, populate the sockets with memory modules with the highest capacity first. For example, if you want to mix 4 GB and 8 GB DIMMs, populate 8 GB DIMMs in the sockets with white release levers and 4 GB DIMMs in the sockets with black release levers.
- Memory modules of different capacities can be mixed provided other memory population rules are followed (for example, 4 GB and 8 GB memory modules can be mixed).
- Mixing of more than two DIMM capacities in a system is not supported.
- Populate two DIMMs per processor (one DIMM per channel) at a time to maximize performance.

## Sample memory configurations

The following table shows sample memory configurations for a single processor configuration.

 **NOTE:** 1R and 2R in the following table indicate single and dual-rank memory modules respectively.

**Table 7. Memory configurations—single processor**

Populated system capacity (in GB)	Memory module size (in GB)	Number of memory modules	Memory module rank, organization, and frequency	memory module slot population
4	4	1	1R, x8, 2133 MT/s,	A1
			1R, x8, 1866 MT/s	
8	4	2	1R, x8, 2133 MT/s,	A1, A2
			1R, x8, 1866 MT/s	
16	4	4	1R, x8, 2133 MT/s,	A1, A2, A3, A4
			1R, x8, 1866 MT/s	
	8	2	2R, x8, 2133 MT/s,	A1, A2
			2R, x8, 1866 MT/s	
32	8	4	2R, x8, 2133 MT/s,	A1, A2, A3, A4
			2R, x8, 1866 MT/s	



Populated system capacity (in GB)	Memory module size (in GB)	Number of memory modules	Memory module rank, organization, and frequency	memory module slot population
	16	2	2R, x8, 2133 MT/s,	A1, A2
			2R, x8, 1866 MT/s	
64	16	4	2R, x8, 2133 MT/s,	A1, A2, A3, A4
			2R, x8, 1866 MT/s	

## Removing memory modules

### Prerequisites

 **CAUTION:** Many repairs may only be done by a certified service technician. You should only perform troubleshooting and simple repairs as authorized in your product documentation, or as directed by the online or telephone service and support team. Damage due to servicing that is not authorized by Dell is not covered by your warranty. Read and follow the safety instructions that came with the product.

1. Ensure that you follow the [Safety instructions](#).
2. Follow the procedure listed in [Before working inside your system](#).

 **WARNING:** The memory modules are hot to touch for some time after the system has been powered down. Allow the memory modules to cool before handling them. Handle the memory modules by the card edges and avoid touching the components or metallic contacts on the memory module.

### Steps

1. Locate the appropriate memory module socket.

 **CAUTION:** Handle each memory module only by the card edges, making sure not to touch the middle of the memory module or metallic contacts.

2. To release the memory module from the socket, simultaneously press the ejectors on both ends of the memory module socket.
3. Lift the memory module away from the chassis.

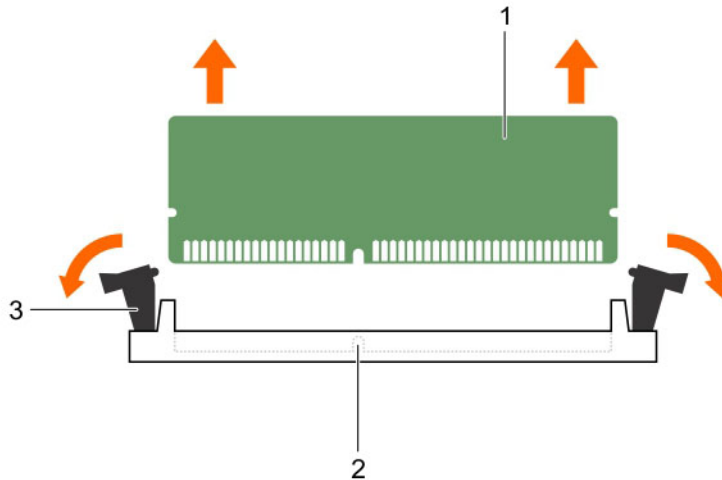

**Figure 20. Removing a memory module**

- |                                     |                         |
|-------------------------------------|-------------------------|
| 1. memory module                    | 2. memory module socket |
| 3. memory module socket ejector (2) |                         |

#### Next steps

1. Install the memory module.
2. Follow the procedure listed in [After working inside your system.](#)

#### Related Tasks

[Installing memory modules](#)

## Installing memory modules

#### Prerequisites

**CAUTION:** Many repairs may only be done by a certified service technician. You should only perform troubleshooting and simple repairs as authorized in your product documentation, or as directed by the online or telephone service and support team. Damage due to servicing that is not authorized by Dell is not covered by your warranty. Read and follow the safety instructions that came with the product.

1. Ensure that you follow the [Safety instructions.](#)
2. Follow the procedure listed in [Before working inside your system.](#)

**WARNING:** The memory modules are hot to touch for some time after the system has been powered down. Allow the memory modules to cool before handling them. Handle the memory modules by the card edges and avoid touching the components or metallic contacts on the memory module.

#### Steps

1. Locate the appropriate memory module socket.

**CAUTION:** Handle each memory module only by the card edges, making sure not to touch the middle of the memory module or metallic contacts.

**CAUTION:** To prevent damage to the memory module or the memory module socket during installation, do not bend or flex the memory module; insert both ends of the memory module simultaneously.

- Align the edge connector of the memory module with the alignment key of the memory module socket, and insert the memory module in the socket.

**NOTE:** The alignment key allows you to install the memory module in the socket in only one orientation.

**CAUTION:** Do not apply pressure at the center of the memory module; apply pressure at both ends of the memory module evenly.

- Press the memory module with your thumbs until the socket levers firmly click into place.

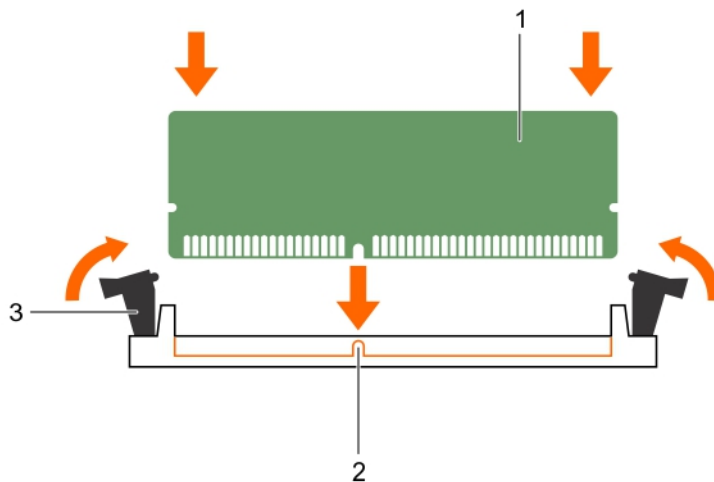

**Figure 21. Installing the memory module**

- |                                     |                  |
|-------------------------------------|------------------|
| 1. memory module                    | 2. alignment key |
| 3. memory module socket ejector (2) |                  |

#### Next steps

- Follow the procedure listed in [After working inside your system](#).
- Press F2 to enter System Setup, and check the **System Memory** setting. The **System Memory Size** should reflect the installed memory.
- If the value is incorrect, one or more of the memory modules may not be installed properly. Ensure that the memory modules are firmly seated in the sockets.
- Run the system memory test in system diagnostics. See [Dell Embedded System Diagnostics](#).

## Cooling fan

Your system supports only one cooling fan.

## Removing the cooling fan

### Prerequisites

△ **CAUTION:** Many repairs may only be done by a certified service technician. You should only perform troubleshooting and simple repairs as authorized in your product documentation, or as directed by the online or telephone service and support team. Damage due to servicing that is not authorized by Dell is not covered by your warranty. Read and follow the safety instructions that came with the product.

△ **CAUTION:** Do not remove or install the cooling fan by holding the blades.

△ **CAUTION:** Never operate your system with the system fan removed. System can overheat and result in shutdown of the system and loss of data.

1. Ensure that you follow the [Safety instructions](#).
2. Follow the procedure listed in [Before working inside your system](#).

### Steps

1. Disconnect the cooling fan power cable from the system board.
2. To ease removal of the cooling fan, stretch the grommets securing the fan to the chassis.
3. Hold the cooling fan by the sides, and slide it out of the grommet.
4. Repeat steps 2 and 3 to release the fan from the remaining grommets.

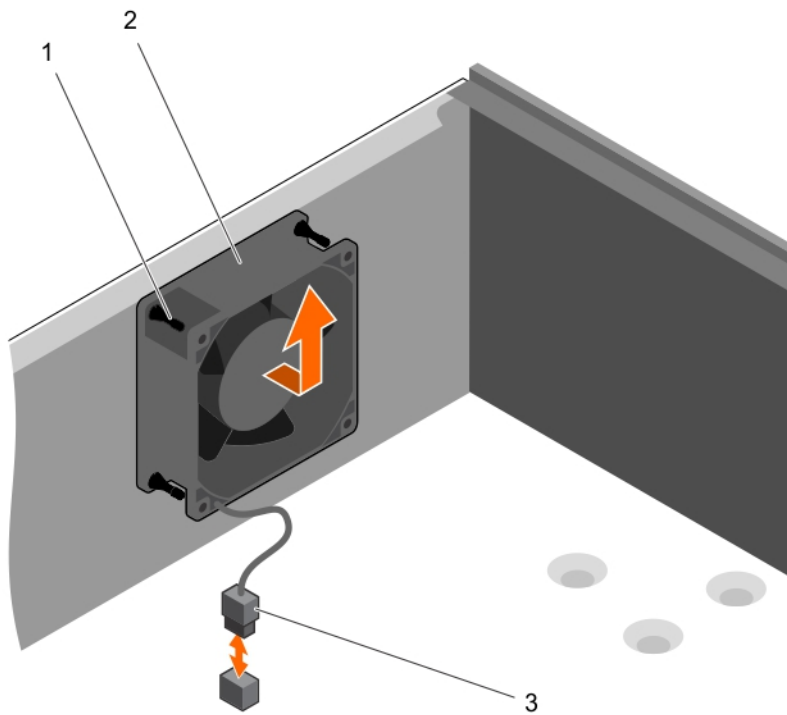

Figure 22. Removing and installing the cooling fan

1. grommets (4)

2. cooling fan

3. cooling fan power cable

#### Next steps

1. Install the cooling fan.
2. Follow the procedure listed in [After working inside your system](#).

#### Related Tasks

[Installing the cooling fan](#)

## Installing the cooling fan

#### Prerequisites

 **CAUTION:** Many repairs may only be done by a certified service technician. You should only perform troubleshooting and simple repairs as authorized in your product documentation, or as directed by the online or telephone service and support team. Damage due to servicing that is not authorized by Dell is not covered by your warranty. Read and follow the safety instructions that came with the product.

 **CAUTION:** Do not remove or install the system fan by holding the blades.

1. Ensure that you follow the [Safety instructions](#).
2. Follow the procedure listed in [Before working inside your system](#).

 **NOTE:** Install the lower two grommets first.

#### Steps

1. Hold the cooling fan by the sides with the cable end facing the bottom of the chassis.
2. Align the four grommets on the chassis with the four holes on the sides of the cooling fan.
3. Pass the grommets through the corresponding holes on the cooling fan.
4. Stretch the grommets and slide the cooling fan toward the chassis until it locks into place.
5. Connect the cooling fan power cable to the connector on the system board.

#### Next steps

Follow the procedure listed in [After working inside your system](#).

## Internal USB memory key (optional)

A USB memory key installed inside your system can be used as a boot device, security key, or mass storage device. The USB connector must be enabled by the **Internal USB Port** option in the **Integrated Devices** screen of System Setup.

To boot from the USB memory key, configure the USB memory key with a boot image and then specify the USB memory key in the boot sequence in System Setup.

 **NOTE:** To locate the internal USB connector (INT\_USB) on the system board, see [System board jumpers and connectors](#).

## Replacing the optional internal USB memory key

### Prerequisites

**CAUTION:** Many repairs may only be done by a certified service technician. You should only perform troubleshooting and simple repairs as authorized in your product documentation, or as directed by the online or telephone service and support team. Damage due to servicing that is not authorized by Dell is not covered by your warranty. Read and follow the safety instructions that came with the product.

1. Ensure that you follow the [Safety instructions](#).
2. Follow the procedure listed in [Before working inside your system](#).

### Steps

1. Locate the USB connector or USB memory key on the system board.

**NOTE:** To locate the internal USB connector on the system board, see [System board jumpers and connectors](#).

2. If installed, remove the USB memory key from the USB connector.
3. Insert the replacement USB memory key into the USB connector.

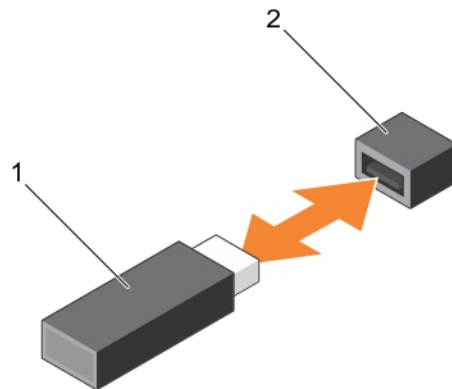

**Figure 23. Replacing the internal USB memory key**

1. USB memory key
2. USB memory key connector

### Next steps

1. Follow the procedure listed in [After working inside your system](#).
2. While booting, press F2 to enter System Setup and verify that the USB memory key is detected by the system.

## Expansion cards

 **NOTE:** An SEL event is logged if an expansion card is unsupported or missing. It does not prevent your system from turning on and no BIOS POST message or F1/F2 pause is displayed.

### Expansion card installation guidelines

Your system supports Generation 3 cards. The following table lists the supported expansion cards:

**Table 8. PCI Express Generation 3 expansion cards supported**

PCIe Slot	Processor Connection	Height	Length	Link Width	Slot Width
1	Processor	Full Height	Half Length	x4	x8
2	Processor	Full Height	Half Length	x8	x16
3	Platform Controller Hub	Full Height	Half Length	x1	x1
4	Platform Controller Hub	Full Height	Half Length	x4	x8

 **NOTE:** All slots support Generation 3 PCIe expansion cards.

 **NOTE:** The expansion cards are not hot swappable.

The following table provides a guide for installing expansion cards to ensure proper cooling and mechanical fit. Install the expansion card by following the card priority and slot priority order as shown in the table.

**Table 9. Expansion card installation order**

Card Priority	Card Type	Form factor	Slot Priority	Maximum Allowed
1	PowerEdge RAID Controller (PERC) H730	Full Height	4, 2, 1	1
	PERC H330	Full Height	4, 2, 1	1
	PERC H830	Full Height	2, 1, 4	2
2	1 Gb NICs Quad Port (Intel)	Full Height	1, 2, 4	3
	1 G NICs Quad Port (Broadcom)	Full Height	1, 2, 4	3
	1 Gb NICs Dual Port (Intel)	Full Height	1, 2, 4	3
	1 G NICs Dual Port (Broadcom)	Full Height	3, 1, 4, 2	3
3	12 Gb SAS HBA	Full Height	2, 1, 4	3

## Removing an expansion card

### Prerequisites

 **CAUTION:** Many repairs may only be done by a certified service technician. You should only perform troubleshooting and simple repairs as authorized in your product documentation, or as directed by the online or telephone service and support team. Damage due to servicing that is not authorized by Dell is not covered by your warranty. Read and follow the safety instructions that came with the product.

1. Ensure that you follow the [Safety instructions](#).
2. Follow the procedure listed in [Before working inside your system](#).

### Steps

1. Disconnect all the cables from the expansion card.
2. Press and push out the expansion card release latch.
3. Holding the card by its edge, pull the card to disengage it from the connector and lift the card out of the chassis.
4. If you are removing the card permanently, install an expansion card blank in the empty card slot. The steps for installing or removing an expansion card blank are similar to installing or removing an expansion card.



**NOTE:** Expansion card blanks must be installed into empty expansion card slots to maintain FCC certification of the system. The blanks also keep dust and dirt out of the system and aid in proper cooling and airflow inside the system.

5. Push the expansion card latch toward the system until it clicks into place.



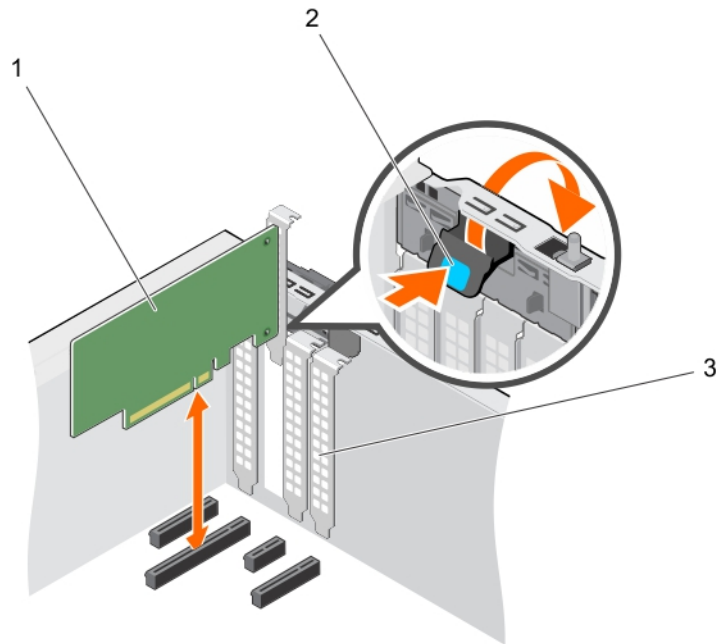

**Figure 24. Removing and installing an expansion card**

1. expansion card
2. expansion card latch
3. expansion card blank

#### Next steps

1. Install an expansion card.
2. Follow the procedure listed in [After working inside your system](#).

#### Related Tasks

[Installing an expansion card](#)

## Installing an expansion card

#### Prerequisites

**△ CAUTION:** Many repairs may only be done by a certified service technician. You should only perform troubleshooting and simple repairs as authorized in your product documentation, or as directed by the online or telephone service and support team. Damage due to servicing that is not authorized by Dell is not covered by your warranty. Read and follow the safety instructions that came with the product.

1. Ensure that you follow the [Safety instructions](#).
2. Follow the procedure listed in [Before working inside your system](#).

#### Steps

1. Unpack the expansion card and prepare it for installation.

For instructions, see the documentation accompanying the card.

2. Press and push out the expansion card release latch to open it.
3. Remove the expansion card blank if you are installing a new expansion card.

The steps for installing or removing an expansion card blank are similar to installing or removing an expansion card.

 **NOTE:** Keep the expansion card blank for future use. Expansion card blank must be installed into empty expansion card slots to maintain FCC certification of the system. The blanks also keep dust and dirt out of the system and aid in proper cooling and airflow inside the system.

4. Holding the expansion card by its edges, position the card so that the card-edge connector aligns with the expansion card connector.
5. Push the expansion card into the expansion card slot until the expansion card is fully seated.
6. Press the expansion card latch down toward the system until it clicks into place.

#### Next steps

Follow the procedure listed in [After working inside your system](#).

## iDRAC port card (optional)

The iDRAC port card consists of the SD vFlash card slot and an iDRAC port. The iDRAC port card features a dedicated NIC port and is used for remote, advanced management of the system through the network.

An SD vFlash card is a Secure Digital (SD) card that plugs into the SD vFlash card slot in the iDRAC port card. It provides persistent on-demand local storage and a custom deployment environment that enables automation of server configuration, scripts, and imaging. It emulates a USB device. For more information, see the Integrated Dell Remote Access Controller User's Guide at [Dell.com/idracmanuals](http://Dell.com/idracmanuals).

### Replacing an optional SD vFlash card

1. Locate the SD vFlash card slot at the back of the chassis.
2. To remove the SD vFlash card, push the SD vFlash card inward to release it, and pull the SD vFlash card from the SD vFlash card slot.

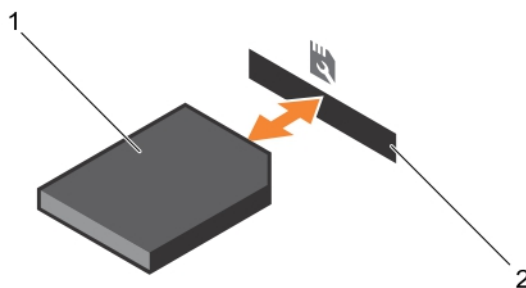

**Figure 25. Removing and installing the SD vFlash card**

1. SD vFlash card

2. SD vFlash card slot

3. Install a replacement SD vFlash card by inserting the contact-pin end of the SD vFlash card into the SD vFlash card slot on the iDRAC port card module.

 **NOTE:** The slot is keyed to ensure correct insertion of the SD vFlash card.

4. Press the SD vFlash card inward to lock it into the SD vFlash card slot.

## Removing the optional iDRAC port card

### Prerequisites

 **CAUTION:** Many repairs may only be done by a certified service technician. You should only perform troubleshooting and simple repairs as authorized in your product documentation, or as directed by the online or telephone service and support team. Damage due to servicing that is not authorized by Dell is not covered by your warranty. Read and follow the safety instructions that came with the product.

1. Ensure that you follow the [Safety instructions](#).
2. Follow the procedure listed in [Before working inside your system](#).
3. Keep the Phillips #2 screwdriver ready.
4. If connected, disconnect the network cable from the iDRAC port card.

### Steps

1. Loosen the screw securing the iDRAC port card holder to the system board.
2. Pull the iDRAC port card to disengage it from the iDRAC port card connector on the system board, and remove the card from the chassis.

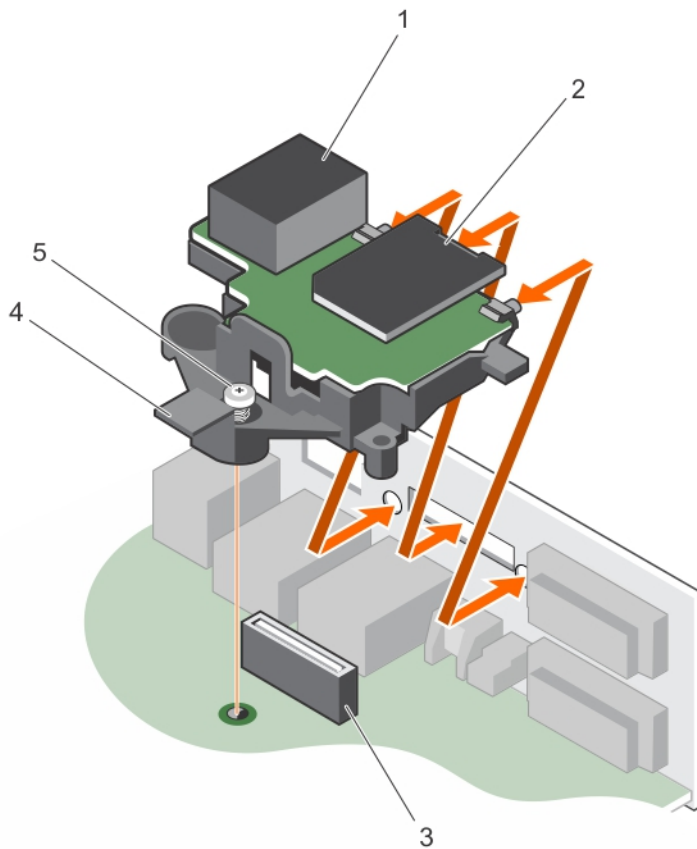

**Figure 26. Removing and installing the iDRAC port card**

- |                              |                              |
|------------------------------|------------------------------|
| 1. iDRAC port                | 2. SD vFlash media card slot |
| 3. iDRAC port card connector | 4. iDRAC port card holder    |
| 5. captive screw             |                              |

#### Next steps

1. Install the iDRAC port card.
2. If disconnected, reconnect the network cable.
3. Follow the procedure listed in [After working inside your system](#).

#### Related Tasks

[Installing the optional iDRAC port card](#)

## Installing the optional iDRAC port card

#### Prerequisites

**⚠ CAUTION:** Many repairs may only be done by a certified service technician. You should only perform troubleshooting and simple repairs as authorized in your product documentation, or as directed by the online or telephone service and support team. Damage due to servicing that is not authorized by Dell is not covered by your warranty. Read and follow the safety instructions that came with the product.

1. Ensure that you follow the [Safety instructions](#).
2. Follow the procedure listed in [Before working inside your system](#).
3. Keep the Phillips #2 screwdriver ready.

#### Steps

1. Align and insert the tabs on the iDRAC port card into the slots on the chassis.
2. Insert the iDRAC port card into the connector on the system board.
3. Tighten the screw that secures the iDRAC port card holder to the system board.

#### Next steps

1. If disconnected, reconnect the network cable.
2. Follow the procedure listed in [After working inside your system](#).

## Processors and heat sinks

Use the following procedure when:

- Removing and installing a heat sink
- Installing an additional processor
- Replacing a processor

 **NOTE:** To ensure proper system cooling, you must install a processor blank in any empty processor socket.

## Removing the heat sink

#### Prerequisites

 **CAUTION:** Many repairs may only be done by a certified service technician. You should only perform troubleshooting and simple repairs as authorized in your product documentation, or as directed by the online or telephone service and support team. Damage due to servicing that is not authorized by Dell is not covered by your warranty. Read and follow the safety instructions that came with the product.

 **CAUTION:** Never remove the heat sink from a processor unless you intend to remove the processor. The heat sink is necessary to maintain proper thermal conditions.

 **NOTE:** This is a Field Replaceable Unit (FRU). Removal and installation procedures should be performed only by Dell certified service technicians.

1. Ensure that you follow the [Safety instructions](#).
2. Keep the Phillips #2 screwdriver ready.
3. Follow the procedure listed in [Before working inside your system](#).
4. Disconnect the heat sink cooling fan power cable connector from the connector on the system board.

 **WARNING:** The heat sink and processor are hot to the touch for some time after the system has been powered down. Allow the heat sink and processor to cool before handling them.

#### Steps

1. Loosen one of the screws that secure the heat sink to the system board.

Allow some time (around 30 seconds) for the heat sink to loosen from the processor.

2. Loosen the screw that is diagonally opposite the screw you first removed.
3. Repeat the procedure for the remaining two screws.
4. Lift the heat sink away from the system.

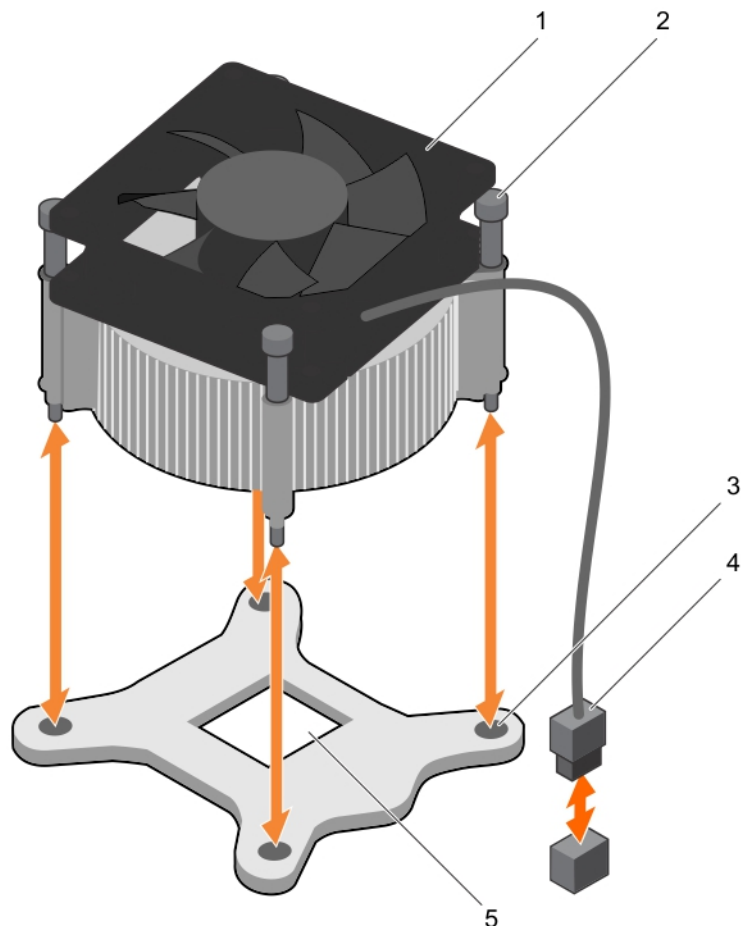

**Figure 27. Removing and installing a heat sink**

- |                     |  |
|---------------------|--|
| 1. heat sink        | 2. captive screw (4)                           |
| 3. slot (4)         | 4. heat sink cooling fan power cable connector |
| 5. processor socket |  |

#### Next steps

1. If you are removing only a faulty heat sink, install the replacement heat sink, if not, remove the processor.
2. Follow the procedure listed in [After working inside your system](#).

#### Related Tasks

[Installing the heat sink](#)

[Removing the processor](#)

## Removing the processor

### Prerequisites

 **CAUTION:** Many repairs may only be done by a certified service technician. You should only perform troubleshooting and simple repairs as authorized in your product documentation, or as directed by the online or telephone service and support team. Damage due to servicing that is not authorized by Dell is not covered by your warranty. Read and follow the safety instructions that came with the product.

 **NOTE:** This is a Field Replaceable Unit (FRU). Removal and installation procedures should be performed only by Dell certified service technicians.

1. Ensure that you follow the [Safety instructions](#).
2. Keep the Phillips #2 screwdriver ready.
3. If you are upgrading your system, download the latest system BIOS version from [Dell.com/support](https://Dell.com/support) and follow the instructions included in the compressed download file to install the update on your system.

 **NOTE:** You can update the system BIOS by using the Dell Lifecycle Controller.

4. Follow the procedure listed in [Before working inside your system](#).
5. Remove the heat sink.

 **WARNING:** The processor will be hot to touch for some time after the system has been powered down. Allow the processor to cool before removing it.

 **CAUTION:** The processor is held in its socket under strong pressure. Be aware that the release lever can spring up suddenly if not firmly held.

### Steps

1. Release the socket lever by pushing the lever down and out from under the tab on the processor shield.
2. Lift the lever upward until the processor shield lifts.

 **CAUTION:** The processor socket pins are fragile and can be permanently damaged. Be careful not to bend the pins in the processor socket when removing the processor out of the socket.

3. Lift the processor out of the socket.

 **NOTE:** After removing the processor, place it in an antistatic container for reuse, return, or temporary storage. Do not touch the bottom of the processor to avoid damage to the processor contacts. Touch only the side edges of the processor.

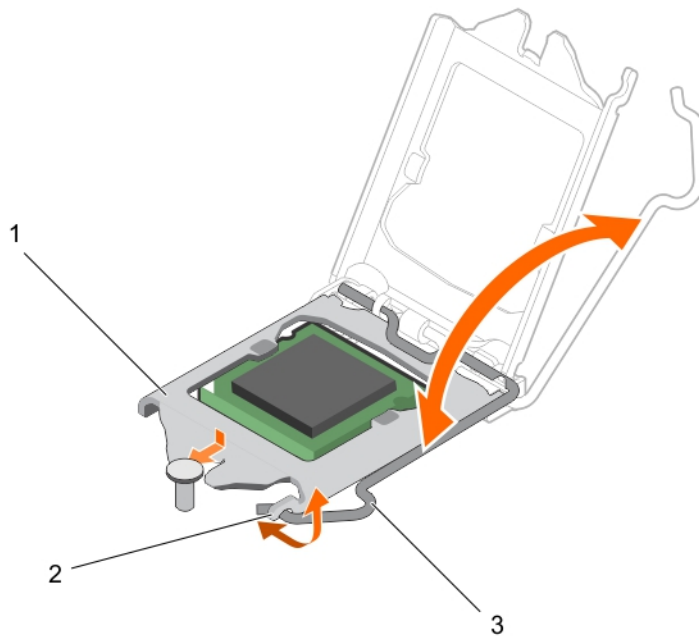

**Figure 28. Opening and closing the processor shield**

- 1. processor shield
- 2. tab on the processor shield
- 3. socket lever



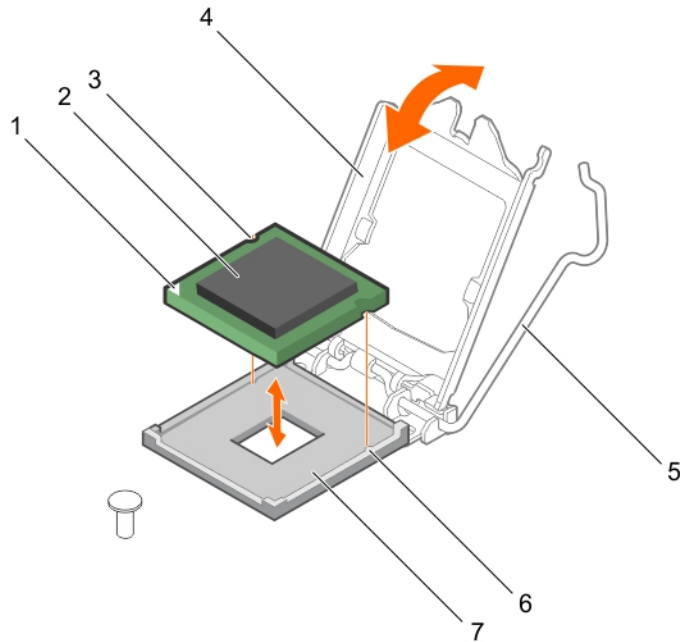

**Figure 29. Removing and installing a processor**

- |                                 |                     |
|---------------------------------|---------------------|
| 1. pin-1 indicator of processor | 2. processor        |
| 3. slot (2)                     | 4. processor shield |
| 5. socket lever                 | 6. socket keys (2)  |
| 7. socket                       |                     |

#### Next steps

1. Replace the processor.
2. Follow the procedure listed in [After working inside your system](#).

#### Related Tasks

- [Removing the heat sink](#)
- [Installing the processor](#)

## Installing the processor

#### Prerequisites

**CAUTION:** Many repairs may only be done by a certified service technician. You should only perform troubleshooting and simple repairs as authorized in your product documentation, or as directed by the online or telephone service and support team. Damage due to servicing that is not authorized by Dell is not covered by your warranty. Read and follow the safety instructions that came with the product.

**NOTE:** This is a Field Replaceable Unit (FRU). Removal and installation procedures should be performed only by Dell certified service technicians.

1. Ensure that you follow the [Safety instructions](#).

2. If you are upgrading your system, download the latest system BIOS version from [Dell.com/support](https://Dell.com/support) and follow the instructions included in the compressed download file to install the update on your system.

 **NOTE:** You can update the system BIOS by using the Dell Lifecycle Controller.

3. Follow the procedure listed in [Before working inside your system](#).
4. Remove the cooling shroud.

### Steps

1. Unpack the new processor.

If the processor has previously been used in a system, remove any remaining thermal grease from the processor by using a lint free cloth.

2. Locate the processor socket.

 **CAUTION:** While removing or reinstalling the processor, wipe your hands of any contaminants. Contaminants on the processor contacts such as thermal grease or oil can damage the processor.

3. Align the processor with the socket keys.

 **CAUTION:** Do not use force to seat the processor. When the processor is positioned correctly, it engages easily into the socket.

 **CAUTION:** Positioning the processor incorrectly can permanently damage the system board or the processor. Be careful not to bend the pins in the socket.

4. Align the pin-1 indicator of the processor with the triangle on the socket.
5. Place the processor on the socket such that the slots on the processor align with the socket keys.
6. Close the processor shield by sliding it under the retention screw.
7. Lower the socket lever and push it under the tab to lock it.

### Next steps

 **NOTE:** Ensure that you install the heat sink after you install the processor. The heat sink is necessary to maintain proper thermal conditions.

1. Install the heat sink.
2. Follow the procedure listed in [After working inside your system](#).
3. While booting, press F2 to enter System Setup and check that the processor information matches the new system configuration.
4. Run the system diagnostics to verify that the new processor operates correctly.

### Related Tasks

[Installing the heat sink](#)

## Installing the heat sink

### Prerequisites

 **CAUTION:** Many repairs may only be done by a certified service technician. You should only perform troubleshooting and simple repairs as authorized in your product documentation, or as directed by the online or telephone service and support team. Damage due to servicing that is not authorized by Dell is not covered by your warranty. Read and follow the safety instructions that came with the product.

 **NOTE:** This is a Field Replaceable Unit (FRU). Removal and installation procedures should be performed only by Dell certified service technicians.

1. Ensure that you follow the [Safety instructions](#).
2. Keep the Phillips #2 screwdriver ready.
3. Follow the procedure listed in [Before working inside your system](#).
4. Install the processor.

### Steps

1. If you are using an existing heat sink, remove the thermal grease from the heat sink by using a clean lint free cloth.
2. Use the thermal grease syringe included with your processor kit to apply the grease in a thin spiral on the top of the processor as shown in the following figure.

**⚠ CAUTION:** Applying too much thermal grease can result in excess grease coming in contact with and contaminating the processor socket.

**🖋 NOTE:** The thermal grease syringe is intended for one-time use only. Dispose of the syringe after you use it.

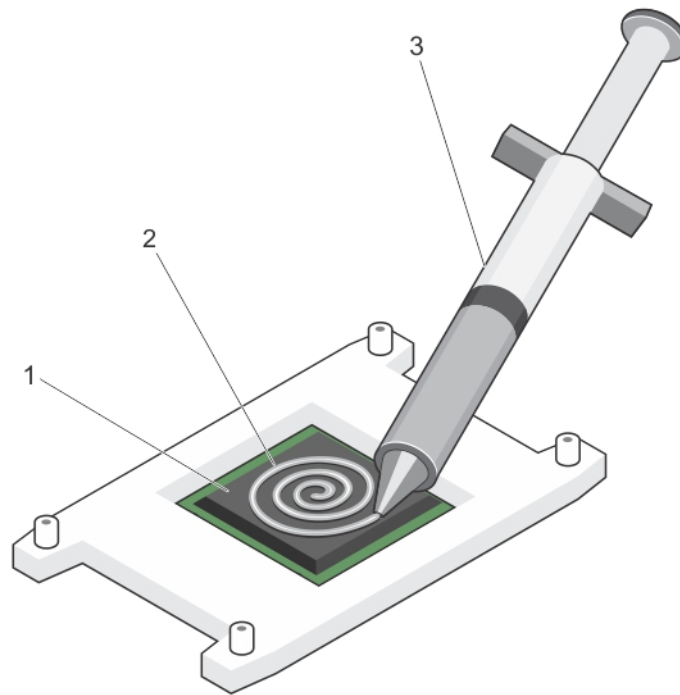

**Figure 30. Applying thermal grease on the top of the processor**

1. processor
  2. thermal grease
  3. thermal grease syringe
3. Place the heat sink onto the processor.
  4. Tighten one of the four screws to secure the heat sink to the system board.
  5. Tighten the screw diagonally opposite to the first screw you tightened.



**NOTE:** Do not overtighten the heat sink retention screws when installing the heat sink. To prevent overtightening, tighten the retention screw until resistance is felt. The screw tension must not be more than 6 in-lb (6.9 kg-cm).

6. Repeat the procedure for the remaining two screws.

#### Next steps

1. Follow the procedure listed in [After working inside your system](#).
2. While booting, press F2 to enter System Setup and check that the processor information matches the new system configuration.
3. Run the system diagnostics to verify that the new processor operates correctly.

## Power supply unit

Your system supports 290 W AC power supply unit.

### Removing the power supply unit (PSU)

#### Prerequisites



**CAUTION:** Many repairs may only be done by a certified service technician. You should only perform troubleshooting and simple repairs as authorized in your product documentation, or as directed by the online or telephone service and support team. Damage due to servicing that is not authorized by Dell is not covered by your warranty. Read and follow the safety instructions that came with the product.

1. Ensure that you follow the [Safety instructions](#).
2. Follow the procedure listed in [Before working inside your system](#).
3. Keep the Phillips #2 screwdriver ready.

#### Steps

1. Disconnect all the power cables from the PSU to the system board.
2. Remove the screws securing the PSU to the chassis.
3. Press the release tab beside the PSU, and slide the PSU toward the front of the system.
4. Lift the PSU out of the chassis.

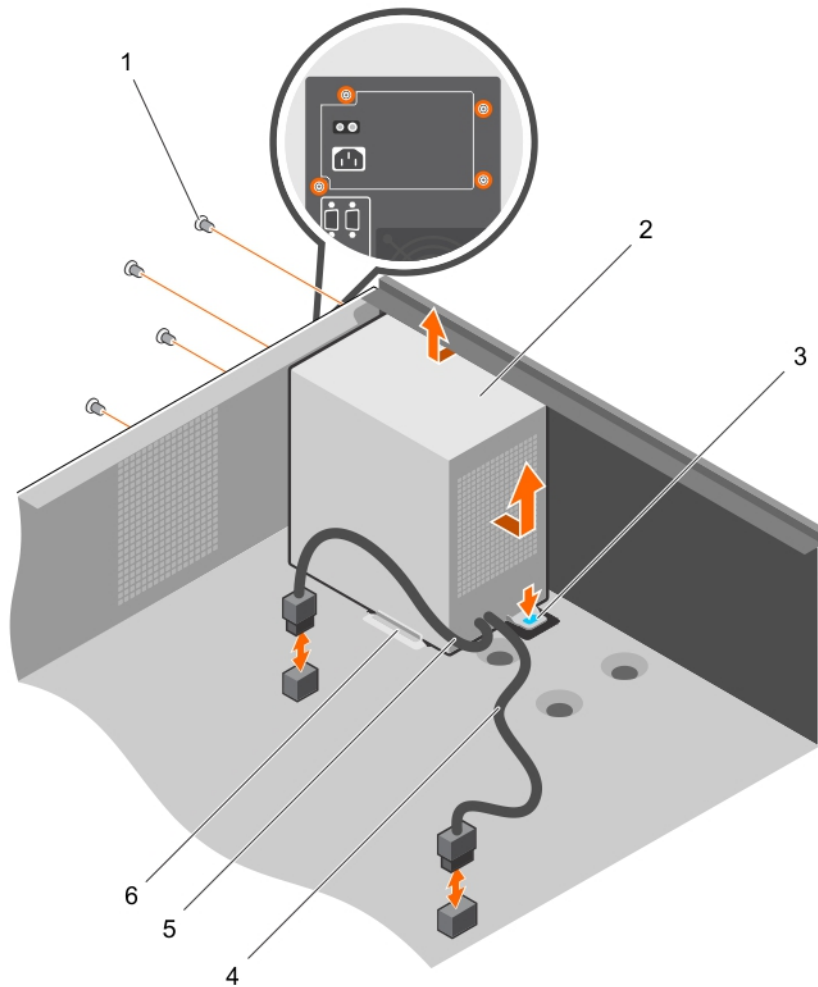

**Figure 31. Removing and installing the PSU**

- |                   |                      |
|-------------------|----------------------|
| 1. screws (4)     | 2. PSU               |
| 3. release tab    | 4. P1 power cable    |
| 5. P2 power cable | 6. PSU support guide |

**Next steps**

1. Install the PSU.
2. Follow the procedure listed in [After working inside your system.](#)

**Related Tasks**

[Installing the power supply unit \(PSU\)](#)

## Installing the power supply unit (PSU)

### Prerequisites

 **CAUTION:** Many repairs may only be done by a certified service technician. You should only perform troubleshooting and simple repairs as authorized in your product documentation, or as directed by the online or telephone service and support team. Damage due to servicing that is not authorized by Dell is not covered by your warranty. Read and follow the safety instructions that came with the product.

1. Ensure that you follow the [Safety instructions](#).
2. Follow the procedure listed in [Before working inside your system](#).
3. Keep the Phillips #2 screwdriver ready.

### Steps

1. Place the PSU in the chassis and slide it toward the back of the chassis.
2. To secure the PSU to the chassis, insert and tighten the screws on the back of the chassis.
3. Connect the power cables to the system board connectors.

### Next steps

Follow the procedure listed in [After working inside your system](#).

## System battery

### Replacing the system battery

#### Prerequisites

1. Ensure that you follow the [Safety instructions](#).
2. Follow the procedure listed in [Before working inside your system](#).
3. Keep the plastic scribe ready.

 **WARNING:** There is a danger of a new battery exploding if it is incorrectly installed. Replace the battery only with the same or equivalent type recommended by the manufacturer. For more information, see the safety information that shipped with your system.

 **CAUTION:** Many repairs may only be done by a certified service technician. You should only perform troubleshooting and simple repairs as authorized in your product documentation, or as directed by the online or telephone service and support team. Damage due to servicing that is not authorized by Dell is not covered by your warranty. Read and follow the safety instructions that came with the product.

 **NOTE:** This is a Field Replaceable Unit (FRU). Removal and installation procedures must be performed only by Dell certified service technicians.

### Steps

1. Locate the battery socket. For more information, see [System board jumpers and connectors](#).

 **CAUTION:** To avoid damage to the battery connector, you must firmly support the connector while installing or removing a battery.

2. Use a plastic scribe to pry out the system battery as shown in the following illustration:

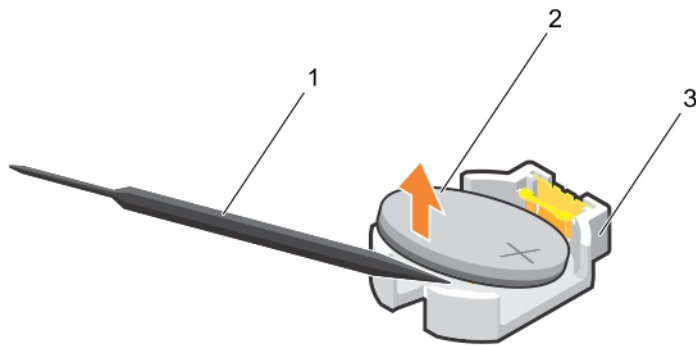

**Figure 32. Removing the system battery**

1. plastic scribe
2. positive side of the battery connector
3. securing tabs
3. Install a new system battery by holding the battery with the "+" sign facing up and slide it under the securing tabs.
4. Press the battery into the connector until it snaps into place.

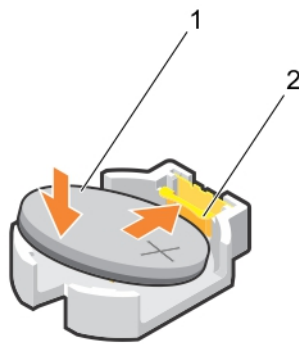

**Figure 33. Installing the system battery**

1. positive side of the battery connector
2. battery connector

#### Next steps

1. Follow the procedure listed in [After working inside your system](#).
2. While booting, press F2 to enter System Setup and ensure that the battery is operating properly.
3. Enter the correct time and date in the System Setup **Time** and **Date** fields.
4. Exit System Setup.

# System board

## Removing the system board

### Prerequisites

 **CAUTION:** Many repairs may only be done by a certified service technician. You should only perform troubleshooting and simple repairs as authorized in your product documentation, or as directed by the online or telephone service and support team. Damage due to servicing that is not authorized by Dell is not covered by your warranty. Read and follow the safety instructions that came with the product.

 **NOTE:** This is a Field Replaceable Unit (FRU). Removal and installation procedures must be performed only by Dell certified service technicians.

 **CAUTION:** If you are using the Trusted Program Module (TPM) with an encryption key, you may be prompted to create a recovery key during program or System Setup. Be sure to create and safely store this recovery key. If you replace this system board, you must supply the recovery key when you restart your system or program before you can access the encrypted data on your hard drives.

 **CAUTION:** Do not attempt to remove the TPM plug-in module from the system board. After the TPM plug-in module is installed, it is cryptographically bound to that specific system board. Any attempt to remove an installed TPM plug-in module breaks the cryptographic binding, and it cannot be re-installed or installed on another system board.

1. Ensure that you follow the [Safety instructions](#).
2. Keep the Phillips #2 screwdriver ready.
3. Follow the procedure listed in [Before working inside your system](#).
4. Remove the following components:
  - a. memory modules
  - b. expansion cards
  - c. heat sink and processor
  - d. iDRAC port card, if installed

### Steps

1. Disconnect all cables from the system board.

 **CAUTION:** Take care not to damage the system identification button while removing the system board from the chassis.

2. Remove the screws on the system board, and slide the system board toward the front of the chassis.
3. Hold the system board by the touch points and lift it out of the chassis.

 **CAUTION:** To prevent damage to the system board, do not lift the system board by holding a memory module, processor, or other components; hold the system board by its edges only.



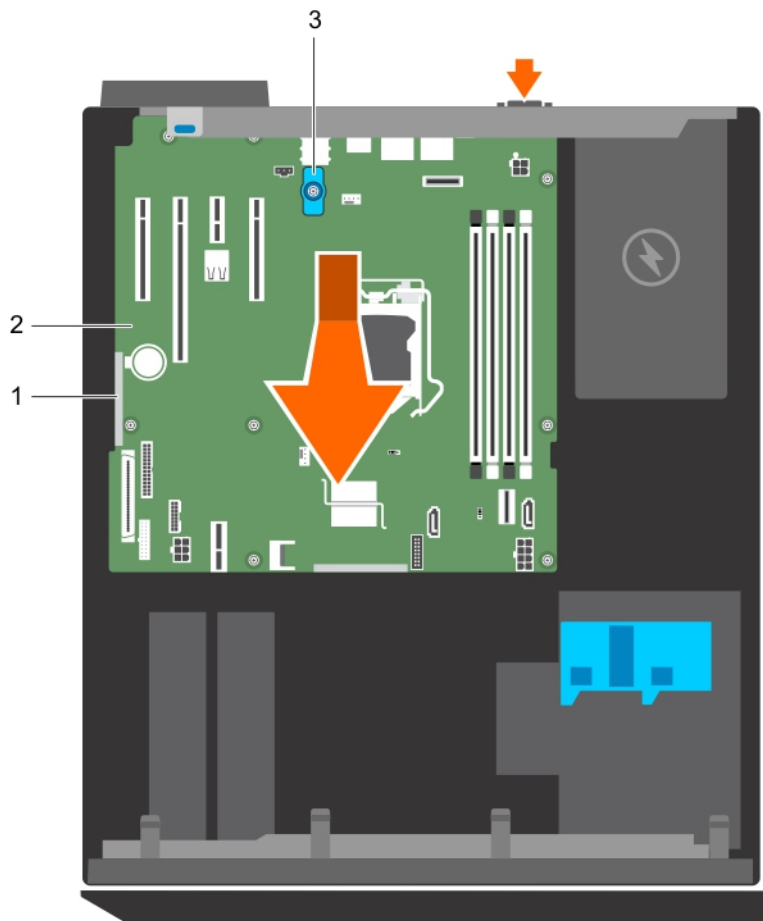

**Figure 34. Removing and installing the system board**

- 1. touch point (2)
- 2. system board
- 3. system board t-handle post

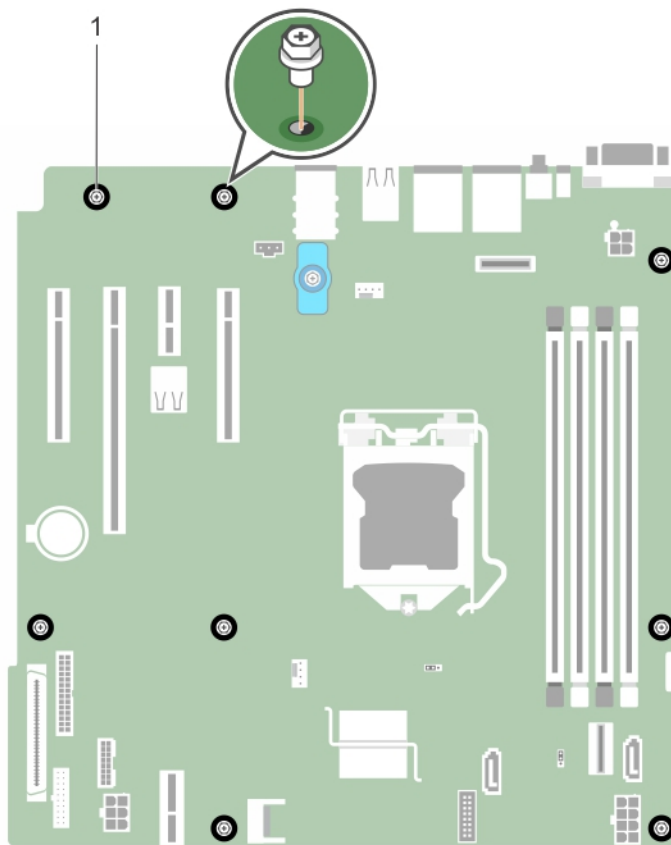

**Figure 35. Removing and installing the screws on the system board**

1. screw (8)

#### Next steps

1. Install the system board.

#### Related Tasks

- [Removing memory modules](#)
- [Removing an expansion card](#)
- [Removing the heat sink](#)
- [Removing the processor](#)
- [Removing the optional iDRAC port card](#)

## Installing the system board

#### Prerequisites

**⚠ CAUTION:** Many repairs may only be done by a certified service technician. You should only perform troubleshooting and simple repairs as authorized in your product documentation, or as directed by the online or telephone service and support team. Damage due to servicing that is not authorized by Dell is not covered by your warranty. Read and follow the safety instructions that came with the product.

 **NOTE:** This is a Field Replaceable Unit (FRU). Removal and installation procedures must be performed only by Dell certified service technicians.

 **CAUTION:** Do not lift the system board by holding a memory module, processor, or other components.

 **CAUTION:** Take care not to damage the system identification button while placing the system board into the chassis.

1. Ensure that you follow the [Safety instructions](#).
2. Follow the procedure listed in [Before working inside your system](#).
3. Keep the Phillips #2 screwdriver ready.

### Steps

1. Hold the system board by its edges, and orient it toward the back of the chassis.
2. Lower the system board into the chassis until the connectors at the back of the system board align with the slots on the back of the chassis.
3. Tighten the screws that secure the system board to the chassis.

### Next steps

1. If required, install the Trusted Platform Module (TPM). See, [Installing the Trusted Platform Module](#).
2. Reinstall the following components:
  - a. memory modules
  - b. heat sink and processor
  - c. iDRAC port card, if removed
3. Reconnect all cables to the system board.

 **NOTE:** Ensure that the cables inside the system are routed through the cable routing latch.
4. Follow the procedure listed in [After working inside your system](#).
5. Import your new or existing iDRAC Enterprise license. For more information, see the Integrated Dell Remote Access Controller User's Guide, at [Dell.com/idracmanuals](http://Dell.com/idracmanuals).
6. Ensure that you perform the following steps:
  - a. If the service tag is not backed up in the backup flash device, enter the system service tag manually. See [Entering the system service tag by using System Setup](#).
  - b. Update the BIOS and iDRAC versions.
  - c. Re-enable the Trusted Platform Module (TPM). See [Re-enabling the TPM for BitLocker users](#) or [Re-enabling the TPM for TXT users](#).

### Related Tasks

- [Installing memory modules](#)
- [Installing the processor](#)
- [Installing the heat sink](#)
- [Installing the optional iDRAC port card](#)

## Entering the system service tag by using System Setup

1. Turn on the system.
2. Press F2 to enter System Setup.
3. Click **Service Tag Settings**.

4. Enter the service tag.



**NOTE:** You can enter the service tag only when the **service tag** field is empty. Ensure that you enter the correct service tag. After the service tag is entered, it cannot be updated or changed.

5. Click **Ok**.
6. Import your new or existing iDRAC Enterprise license.

For more information, see the Integrated Dell Remote Access Controller User's Guide, at [Dell.com/idracmanuals](http://Dell.com/idracmanuals).

## Trusted Platform Module

The Trusted Platform Module (TPM) is used to generate or store keys, protect or authenticate passwords, and create or store digital certificates. TPM can also be used to enable the BitLocker hard drive encryption feature on a Windows Server.



**CAUTION:** Do not attempt to remove the Trusted Platform Module (TPM) from the system board. Once the TPM is installed, it is cryptographically bound to that specific system board. Any attempt to remove an installed TPM breaks the cryptographic binding, and it cannot be re-installed or installed on another system board.



**NOTE:** This is a Field Replaceable Unit (FRU). Removal and installation procedures must be performed only by Dell certified service technicians.

## Installing the Trusted Platform Module

### Prerequisites



**CAUTION:** Many repairs may only be done by a certified service technician. You should only perform troubleshooting and simple repairs as authorized in your product documentation, or as directed by the online or telephone service and support team. Damage due to servicing that is not authorized by Dell is not covered by your warranty. Read and follow the safety instructions that came with the product.



**NOTE:** This is a Field Replaceable Unit (FRU). Removal and installation procedures should be performed only by Dell certified service technicians.

1. Ensure that you follow the [Safety instructions](#).
2. Follow the procedure listed in [Before working inside your system](#).

### Steps

1. Locate the Trusted Platform Module (TPM) connector on the system board.



**NOTE:** To locate the internal USB connector on the system board, see [System board jumpers and connectors](#).

2. Align the edge connectors on the TPM with the slot on the TPM connector.
3. Insert the TPM into the TPM connector such that the plastic bolt aligns with the slot on the system board.
4. Press the plastic bolt until the bolt snaps into place.

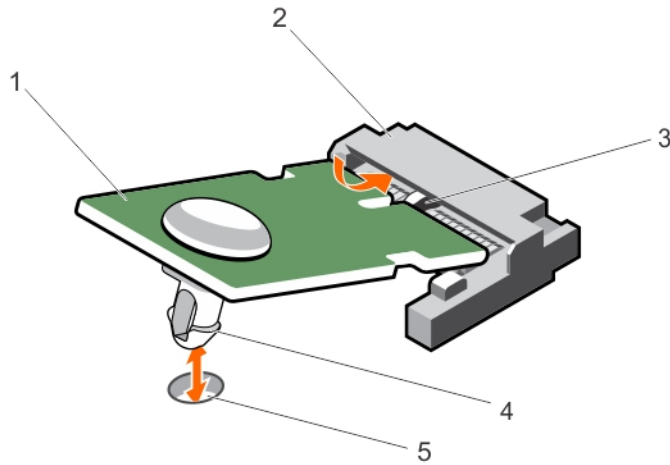

**Figure 36. Installing the TPM**

- |                              |                  |
|------------------------------|------------------|
| 1. TPM                       | 2. TPM connector |
| 3. slot on the TPM connector | 4. plastic bolt  |
| 5. slot on the system board  |                  |

#### Next steps

1. Install the system board.
2. Follow the procedure listed in [After working inside your system](#).

#### Re-enabling the TPM for BitLocker users

Initialize the TPM.

For more information about initializing the TPM, see <http://technet.microsoft.com/en-us/library/cc753140.aspx>.

The **TPM Status** changes to **Enabled, Activated**.

#### Re-enabling the TPM for TXT users

1. While booting your system, press F2 to enter System Setup.
2. In the **System Setup Main Menu**, click **System BIOS** → **System Security Settings**.
3. In the **TPM Security** option, select **On with Pre-boot Measurements**.
4. In the **TPM Command** option, select **Activate**.
5. Save the settings.
6. Restart your system.
7. Enter System Setup again.

8. In the **System Setup Main Menu**, click **System BIOS** → **System Security Settings**.
9. In the **Intel TXT** option, select **On**.

# Troubleshooting your system

## Safety first—for you and your system

 **CAUTION:** Many repairs may only be done by a certified service technician. You should only perform troubleshooting and simple repairs as authorized in your product documentation, or as directed by the online or telephone service and support team. Damage due to servicing that is not authorized by Dell is not covered by your warranty. Read and follow the safety instructions that came with the product.

## Troubleshooting system startup failure

If you boot the system to the BIOS boot mode after installing an operating system from the UEFI Boot Manager, the system stops responding. To avoid this issue, you must boot to the same boot mode in which you installed the operating system.

For all other startup issues, note the system messages that appear on the screen.

## Troubleshooting external connections

Before troubleshooting any external devices, ensure that all external cables are securely attached to the external connectors on your system before troubleshooting any external devices.

## Troubleshooting the video subsystem

### Steps

1. Check the power connections to the monitor.
2. Check the video interface cabling from the system to the monitor.
3. Run the appropriate diagnostic test.

If the tests run successfully, the problem is not related to video hardware.

### Next steps

If the tests fail, see [Getting Help](#).

## Troubleshooting a USB device

### Prerequisites

 **NOTE:** Follow steps 1 to 6 to troubleshoot a USB keyboard or mouse. For other USB devices, go to step 7.

### Steps

1. Disconnect the keyboard and/or mouse cables from the system and reconnect them.
2. If the problem persists, connect the keyboard and/or mouse to another USB port on the system.
3. If the problem is resolved, restart the system, enter System Setup, and check if the non-functioning USB ports are enabled.

 **NOTE:** Older operating systems may not support USB 3.0.

4. Check if USB 3.0 is enabled in System Setup. If enabled, disable it and see if the issue is resolved.
5. In **iDRAC Settings Utility**, ensure that **USB Management Port Mode** is configured as **Automatic** or **Standard OS Use**.
6. If the problem is not resolved, replace the keyboard and/or mouse with a known working keyboard or mouse.  
If the problem is not resolved, proceed to step 7 to troubleshoot other USB devices attached to the system.
7. Turn off all attached USB devices, and disconnect them from the system.
8. Restart the system.
9. If your keyboard is functioning, enter System Setup, verify that all USB ports are enabled on the **Integrated Devices** screen. If your keyboard is not functioning, use remote access to enable or disable the USB options.
10. Check if USB 3.0 is enabled in System Setup. If it is enabled, disable it and restart your system.
11. If the system is not accessible, reset the NVRAM\_CLR jumper inside your system and restore the BIOS to the default settings.
12. In the **iDRAC Settings Utility**, ensure that **USB Management Port Mode** is configured as **Automatic** or **Standard OS Use**.
13. Reconnect and turn on each USB device one at a time.
14. If a USB device causes the same problem, turn off the device, replace the USB cable with a known good cable, and turn on the device.

### Next steps

If all troubleshooting fails, see [Getting Help](#).

## Troubleshooting a serial I/O device

### Steps

1. Turn off the system and any peripheral devices connected to the serial port.
2. Swap the serial interface cable with a known working cable, and turn on the system and the serial device.  
If the problem is resolved, replace the interface cable with a known working cable.
3. Turn off the system and the serial device, and swap the serial device with a compatible device.
4. Turn on the system and the serial device.

### Next steps

If the problem persists, see [Getting Help](#).



# Troubleshooting an NIC

## Steps

1. Run the appropriate diagnostic test. For more information, see [Using system diagnostics](#) for the available diagnostic tests.
2. Restart the system and check for any system messages pertaining to the NIC controller.
3. Check the appropriate indicator on the NIC connector:
  - If the link indicator does not glow, the cable connected might be disengaged.
  - If the activity indicator does not glow, the network driver files might be damaged or missing. Install or replace the drivers as necessary. For more information, see the NIC documentation.
  - If the problem persists, use another connector on the switch or hub.
4. Ensure that the appropriate drivers are installed and the protocols are bound. For more information, see the NIC documentation.
5. Enter System Setup and confirm that the NIC ports are enabled on the **Integrated Devices** screen.
6. Ensure that all the NICs, hubs, and switches on the network are set to the same data transmission speed and duplex. For more information, see the documentation for each network device.
7. Ensure that all network cables are of the proper type and do not exceed the maximum length.

## Next steps

If all troubleshooting fails, see [Getting Help](#).

# Troubleshooting a wet system

## Prerequisites



**CAUTION:** Many repairs may only be done by a certified service technician. You should only perform troubleshooting and simple repairs as authorized in your product documentation, or as directed by the online or telephone service and support team. Damage due to servicing that is not authorized by Dell is not covered by your warranty. Read and follow the safety instructions that came with the product.

## Steps

1. Turn off the system and attached peripherals, and disconnect the system from the electrical outlet.
2. Remove the system cover.
3. Remove the following components from the system:
  - hard drives
  - hard drive backplane
  - USB memory key
  - hard drive tray
  - cooling shroud
  - expansion card risers (if present)
  - expansion cards
  - power supply unit(s)
  - cooling fan assembly (if present)
  - cooling fans
  - processor(s) and heat sink(s)

- memory modules
4. Let the system dry thoroughly for at least 24 hours.
  5. Reinstall the components you removed in step 3 except the expansion cards.
  6. Install the system cover.
  7. Turn on the system and attached peripherals.  
If the system does not start properly, see [Getting Help](#).
  8. If the system starts properly, shut down the system, and reinstall all the expansion cards that you removed.
  9. Run the appropriate diagnostic test. For more information, see [Using System Diagnostics](#).

#### Next steps

If the tests fail, see [Getting Help](#).

## Troubleshooting a damaged system

#### Prerequisites



**CAUTION:** Many repairs may only be done by a certified service technician. You should only perform troubleshooting and simple repairs as authorized in your product documentation, or as directed by the online or telephone service and support team. Damage due to servicing that is not authorized by Dell is not covered by your warranty. Read and follow the safety instructions that came with the product.

#### Steps

1. Turn off the system and attached peripherals, and disconnect the system from the electrical outlet.
2. Remove the system cover.
3. Ensure that the following components are properly installed:
  - cooling shroud
  - expansion card risers (if present)
  - expansion cards
  - power supply unit(s)
  - cooling fan assembly (if present)
  - cooling fans
  - processor(s) and heat sink(s)
  - memory modules
  - hard drive carriers
4. Ensure that all cables are properly connected.
5. Install the system cover.
6. Run the appropriate diagnostic test. For more information, see [Using System Diagnostics](#).

#### Next steps

If the tests fail, see [Getting Help](#).

# Troubleshooting the system battery

## Prerequisites

 **CAUTION:** Many repairs may only be done by a certified service technician. You should only perform troubleshooting and simple repairs as authorized in your product documentation, or as directed by the online or telephone service and support team. Damage due to servicing that is not authorized by Dell is not covered by your warranty. Read and follow the safety instructions that came with the product.

 **NOTE:** If the system is turned off for long periods of time (for weeks or months), the NVRAM may lose its system configuration information. This situation is caused by a defective battery.

 **NOTE:** Some software may cause the system time to speed up or slow down. If the system seems to operate normally except for the time set in System Setup, the problem may be caused by a software, rather than by a defective battery.

## Steps

1. Re-enter the time and date in System Setup.
2. Turn off the system, and disconnect it from the electrical outlet for at least an hour.
3. Reconnect the system to the electrical outlet, and turn on the system.
4. Enter System Setup.

If the date and time displayed in System Setup are not correct, check the System Error Log (SEL) for system battery messages.

## Next steps

If the problem persists, see [Getting Help](#).

# Troubleshooting power supply units

 **CAUTION:** Many repairs may only be done by a certified service technician. You should only perform troubleshooting and simple repairs as authorized in your product documentation, or as directed by the online or telephone service and support team. Damage due to servicing that is not authorized by Dell is not covered by your warranty. Read and follow the safety instructions that came with the product.

## Troubleshooting power source problems

1. Press the power button to ensure that your system is turned on. If the power indicator does not glow when the power button is pressed, press the power button firmly.
2. Plug in another working PSU to ensure that the system board is not faulty.
3. Ensure that no loose connections exist.  
For example, loose power cables.
4. Ensure that the power source meets applicable standards.
5. Ensure that there are no short circuits.
6. Have a qualified electrician check the line voltage to ensure that it meets the required specifications.

## Power supply unit problems

1. Ensure that no loose connections exist.

For example, loose power cables.

2. Ensure that the power supply handle/LED indicates that the power supply is working properly.  
For more information about power supply unit indicators, see [Power indicator codes for power supply unit](#).
3. If you have recently upgraded your system, ensure that the power supply unit has enough power to support the new system.
4. If you have a redundant power supply configuration, ensure that both the power supply units are of the same type and wattage.
5. Ensure that you use only power supply units with the Extended Power Performance (EPP) label on the back.
6. Re-seat the power supply unit.



**NOTE:** After installing a power supply unit, allow several seconds for the system to recognize the power supply unit and determine if it is working properly.

If the problem persists, see [Getting Help](#).

## Troubleshooting cooling problems



**CAUTION:** Many repairs may only be done by a certified service technician. You should only perform troubleshooting and simple repairs as authorized in your product documentation, or as directed by the online or telephone service and support team. Damage due to servicing that is not authorized by Dell is not covered by your warranty. Read and follow the safety instructions that came with the product.

Ensure that the following conditions exist:

- System cover, cooling shroud, EMI filler panel, memory module blank, or back filler bracket is not removed.
- Ambient temperature is not higher than the system specific ambient temperature.
- External airflow is not obstructed.
- A cooling fan is not removed or has not failed.
- The expansion card installation guidelines have been followed.

Additional cooling can be added by one of the following methods:

From the iDRAC web GUI:

1. Click **Hardware** → **Fans** → **Setup**.
2. From the **Fan Speed Offset** drop-down list, select the cooling level needed or set the minimum fan speed to a custom value.

From F2 System Setup:

1. Select **iDRAC Settings** → **Thermal**, and set a higher fan speed from the fan speed offset or minimum fan speed.

From RACADM commands:

1. Run the command `racadm help system.thermalsettings`

For more information, see the Integrated Dell Remote Access User's Guide at [Dell.com/idracmanuals](http://Dell.com/idracmanuals).

# Troubleshooting cooling fans

## Prerequisites

 **CAUTION:** Many repairs may only be done by a certified service technician. You should only perform troubleshooting and simple repairs as authorized in your product documentation, or as directed by the online or telephone service and support team. Damage due to servicing that is not authorized by Dell is not covered by your warranty. Read and follow the safety instructions that came with the product.

 **NOTE:** The fan number is referenced by the systems management software. In the event of a problem with a particular fan, you can easily identify and replace it by noting down the fan numbers on the cooling fan assembly.

## Steps

1. Remove the system cover.
2. Reseat the fan or the fan's power cable.
3. Install the system cover.
4. Restart the system.

## Next steps

If the problem persists, see [Getting Help](#).

# Troubleshooting system memory

## Prerequisites

 **CAUTION:** Many repairs may only be done by a certified service technician. You should only perform troubleshooting and simple repairs as authorized in your product documentation, or as directed by the online or telephone service and support team. Damage due to servicing that is not authorized by Dell is not covered by your warranty. Read and follow the safety instructions that came with the product.

## Steps

1. If the system is operational, run the appropriate system diagnostic test. See [Using system diagnostics](#) for the available diagnostic tests.  
If the diagnostic tests indicate a fault, follow the corrective actions provided by the diagnostic tests.
2. If the system is not operational, turn off the system and attached peripherals, and unplug the system from the power source. Wait at least for 10 seconds, and then reconnect the system to the power source.
3. Turn on the system and attached peripherals, and note the messages on the screen.  
If an error message is displayed indicating a fault with a specific memory module, go to step 12.
4. Enter System Setup, and check the system memory setting. Make any changes to the memory settings, if needed.  
If the memory settings match the installed memory but the problem still persists, go to step 12.
5. Turn off the system and attached peripherals, and disconnect the system from the electrical outlet.
6. Remove the system cover.
7. Check the memory channels and ensure that they are populated correctly.

 **NOTE:** See the system event log or system messages for the location of the failed memory module. Reinstall the memory device.

8. Reseat the memory modules in their sockets.
9. Install the system.
10. Enter System Setup and check the system memory setting.  
If the problem is not resolved, proceed with step 11.
11. Remove the system cover.
12. If a diagnostic test or error message indicates a specific memory module as faulty, swap or replace the module with a known working memory module.
13. To troubleshoot an unspecified faulty memory module, replace the memory module in the first DIMM socket with a module of the same type and capacity.  
If an error message is displayed on the screen, this may indicate a problem with the installed DIMM type(s), incorrect DIMM installation, or defective DIMM(s). Follow the on-screen instructions to resolve the problem.
14. Install the system cover.
15. As the system boots, observe any error message that is displayed and the diagnostic indicators on the front of the system.
16. If the memory problem persists, repeat step 12 through step 15 for each memory module installed.

#### Next steps

If the problem persists after all memory modules have been checked, see [Getting Help](#).

## Troubleshooting an internal USB key

#### Prerequisites



**CAUTION: Many repairs may only be done by a certified service technician. You should only perform troubleshooting and simple repairs as authorized in your product documentation, or as directed by the online or telephone service and support team. Damage due to servicing that is not authorized by Dell is not covered by your warranty. Read and follow the safety instructions that came with the product.**

#### Steps

1. Enter System Setup and ensure that the **USB key port** is enabled on the **Integrated Devices** screen.
2. Turn off the system and attached peripherals, and disconnect the system from the electrical outlet.
3. Remove the system cover.
4. Locate the USB key and reseat it.
5. Install the system cover.
6. Turn on the system and attached peripherals, and check if the USB key is functioning.
7. If the problem is not resolved, repeat step 2 and step 3.
8. Insert a known working USB key.
9. Install the system cover.

#### Next steps

If the problem is not resolved, see [Getting Help](#).

# Troubleshooting an SD card

## Prerequisites

 **CAUTION:** Many repairs may only be done by a certified service technician. You should only perform troubleshooting and simple repairs as authorized in your product documentation, or as directed by the online or telephone service and support team. Damage due to servicing that is not authorized by Dell is not covered by your warranty. Read and follow the safety instructions that came with the product.

 **NOTE:** Certain SD cards have a physical write-protect switch on the card. If the write-protect switch is turned on, the SD card is not writable.

## Steps

1. Enter System Setup, and ensure that the **Internal SD Card Port** is enabled.
2. Turn off the system, including any attached peripherals, and disconnect the system from the electrical outlet.
3. Remove the system cover.
  -  **NOTE:** When an SD card failure occurs, the internal dual SD module controller notifies the system. On the next restart, the system displays a message indicating the failure. If redundancy is enabled at the time of SD card failure, a critical alert will be logged and chassis health will degrade.
4. Replace the failed SD card with a new SD card.
5. Install the system cover.
6. Reconnect the system to its electrical outlet and turn on the system, including any attached peripherals.
7. Enter System Setup, and ensure that the **Internal SD Card Port** and **Internal SD Card Redundancy** modes are set to the required modes.  
Verify that the correct SD slot is set as **Primary SD Card**.
8. Check if the SD card is functioning properly.
9. If the **Internal SD Card Redundancy** option is set to **Enabled** at the time of the SD card failure, the system prompts you to perform a rebuild.

 **NOTE:** The rebuild is always sourced from the primary SD card to the secondary SD card.

# Troubleshooting an optical drive

## Prerequisites

 **CAUTION:** Many repairs may only be done by a certified service technician. You should only perform troubleshooting and simple repairs as authorized in your product documentation, or as directed by the online or telephone service and support team. Damage due to servicing that is not authorized by Dell is not covered by your warranty. Read and follow the safety instructions that came with the product.

## Steps

1. Try using a different CD or DVD.
2. If the problem is not resolved, enter System Setup and ensure that the integrated SATA controller and the drive's SATA port are enabled.
3. Run the appropriate diagnostic test.

4. Turn off the system and attached peripherals, and disconnect the system from the electrical outlet.
5. If installed, remove the bezel.
6. Remove the system cover.
7. Ensure that the interface cable is securely connected to the optical drive and to the controller.
8. Ensure that a power cable is properly connected to the drive.
9. Install the system cover.

#### Next steps

If the problem is not resolved, see [Getting Help](#).

## Troubleshooting a hard drive

### Prerequisites

 **CAUTION:** Many repairs may only be done by a certified service technician. You should only perform troubleshooting and simple repairs as authorized in your product documentation, or as directed by the online or telephone service and support team. Damage due to servicing that is not authorized by Dell is not covered by your warranty. Read and follow the safety instructions that came with the product.

 **CAUTION:** This troubleshooting procedure can erase data stored on the hard drive. Before you proceed, back up all files on the hard drive.

### Steps

1. Run the appropriate diagnostic test. For more information, see [Using System Diagnostics](#).  
Depending on the results of the diagnostics test, proceed as needed through the following steps.
2. If your system has a RAID controller and your hard drives are configured in a RAID array, perform the following steps:
  - a. Restart the system and press F10 during system startup to run the Dell Lifecycle Controller, and then run the Hardware Configuration wizard to check the RAID configuration.  
See the Dell Lifecycle Controller documentation or online help for information on RAID configuration.
  - b. Ensure that the hard drives are configured correctly for the RAID array.
  - c. Take the hard drive offline and reseal the drive.
  - d. Exit the configuration utility and allow the system to boot to the operating system.
3. Ensure that the required device drivers for your controller card are installed and are configured correctly. See the operating system documentation for more information.
4. Restart the system and enter the System Setup.
5. Verify that the controller is enabled and the drives are displayed in the System Setup.

#### Next steps

If the problem persists, try troubleshooting the expansion cards or see [Getting Help](#).

## Troubleshooting a storage controller

 **CAUTION:** Many repairs may only be done by a certified service technician. You should only perform troubleshooting and simple repairs as authorized in your product documentation, or as directed by the online or telephone service and support team. Damage due to servicing that is not authorized by Dell is not covered by your warranty. Read and follow the safety instructions that came with the product.



 **NOTE:** When troubleshooting a SAS or PERC controller, see the documentation for your operating system and the controller.

1. Run the appropriate diagnostic test. For more information, see [Using system diagnostics](#).
2. Turn off the system and attached peripherals, and disconnect the system from the electrical outlet.
3. Remove the system cover.
4. Verify that the installed expansion cards are compliant with the expansion card installation guidelines.
5. Ensure that each expansion card is firmly seated in its connector.
6. Install the system cover.
7. Reconnect the system to the electrical outlet, and turn on the system and attached peripherals.
8. If the problem is not resolved, turn off the system and attached peripherals, and disconnect the system from the electrical outlet.
9. Remove the system cover.
10. Remove all expansion cards installed in the system.
11. Install the system cover.
12. Reconnect the system to the electrical outlet, and turn on the system and attached peripherals.
13. Run the appropriate diagnostic test. For more information, see [Using system diagnostics](#). If the tests fail, see [Getting Help](#).
14. For each expansion card you removed in step 10, perform the following steps:
  - a. Turn off the system and attached peripherals, and disconnect the system from the electrical outlet.
  - b. Remove the system cover.
  - c. Reinstall one of the expansion cards.
  - d. Install the system cover.
  - e. Run the appropriate diagnostic test. For more information, see [Using system diagnostics](#).

If the tests fail, see [Getting Help](#).

## Troubleshooting expansion cards

### Prerequisites

 **CAUTION:** Many repairs may only be done by a certified service technician. You should only perform troubleshooting and simple repairs as authorized in your product documentation, or as directed by the online or telephone service and support team. Damage due to servicing that is not authorized by Dell is not covered by your warranty. Read and follow the safety instructions that came with the product.

 **NOTE:** When troubleshooting an expansion card, you also have to see the documentation for your operating system and the expansion card.

### Steps

1. Run the appropriate diagnostic test. For more information, see [Using system diagnostics](#).
2. Turn off the system and attached peripherals, and disconnect the system from the electrical outlet.
3. Remove the system cover.
4. Ensure that each expansion card is firmly seated in its connector.
5. Install the system cover.
6. Turn on the system and attached peripherals.

7. If the problem is not resolved, turn off the system and attached peripherals, and disconnect the system from the electrical outlet.
8. Remove the system cover.
9. Remove all expansion cards installed in the system.
10. Install the system cover.
11. Run the appropriate diagnostic test. For more information, see [Using system diagnostics](#).  
If the tests fail, see [Getting Help](#).
12. For each expansion card you removed in step 8, perform the following steps:
  - a. Turn off the system and attached peripherals, and disconnect the system from the electrical outlet.
  - b. Remove the system cover.
  - c. Reinstall one of the expansion cards.
  - d. Install the system cover.
  - e. Run the appropriate diagnostic test. For more information, see [Using system diagnostics](#).
13. If the problem persists, see [Getting Help](#).

## Troubleshooting processors

### Prerequisites



**CAUTION:** Many repairs may only be done by a certified service technician. You should only perform troubleshooting and simple repairs as authorized in your product documentation, or as directed by the online or telephone service and support team. Damage due to servicing that is not authorized by Dell is not covered by your warranty. Read and follow the safety instructions that came with the product.

### Steps

1. Run the appropriate diagnostics test. See [Using system diagnostics](#) for available diagnostic tests.
2. Turn off the system and attached peripherals, and disconnect the system from the electrical outlet.
3. Remove the system cover.
4. Ensure that the processor and heat sink are properly installed.
5. Install the system cover.
6. Run the appropriate diagnostic test. For more information, see [Using system diagnostics](#).
7. If the problem persists, see [Getting Help](#).

## System messages

For a list of event and error messages generated by the system firmware and agents that monitor system components, see the Dell Event and Error Messages Reference Guide at [Dell.com/openmanagemanuals](https://Dell.com/openmanagemanuals) > **OpenManage software**.

### Warning messages

A warning message alerts you to a possible problem and prompts you to respond before the system continues a task. For example, before you format a hard drive, a message warns you that you may lose all data on the hard drive. Warning messages usually interrupt the task and require you to respond by typing y (yes) or n (no).



**NOTE:** Warning messages are generated by either the application or the operating system. For more information, see the documentation that accompanied the operating system or application.

## **Diagnostic messages**

The system diagnostic utilities may issue messages if you run diagnostic tests on your system. For more information about system diagnostics, see [Using system diagnostics](#).

## **Alert messages**

The systems management software generates alert messages for your system. Alert messages include information, status, warning, and failure messages for drive, temperature, fan, and power conditions. For more information, see the systems management software documentation.

## Using system diagnostics

If you experience a problem with your system, run the system diagnostics before contacting Dell for technical assistance. The purpose of running system diagnostics is to test your system hardware without requiring additional equipment or risking data loss. If you are unable to fix the problem yourself, service and support personnel can use the diagnostics results to help you solve the problem.

### Dell Embedded System Diagnostics

 **NOTE:** The Dell Embedded System Diagnostics is also known as Enhanced Pre-boot System Assessment (ePSA) diagnostics.

The Embedded System Diagnostics provides a set of options for particular device groups or devices enabling you to:

- Run tests automatically or in an interactive mode
- Repeat tests
- Display or save test results
- Run thorough tests to introduce additional test options to provide extra information about the failed device(s)
- View status messages that inform you if tests are completed successfully
- View error messages that inform you of problems encountered during testing

### When to use the Embedded System Diagnostics

Run the Embedded System Diagnostics (ePSA) if your system does not boot.

### Running the Embedded System Diagnostics from Boot Manager

1. When the system is booting, press **F11**.
2. Use the up and down arrow keys to select **System Utilities** → **Launch Diagnostics**.  
The **ePSA Pre-boot System Assessment** window is displayed, listing all devices detected in the system. The diagnostics starts executing the tests on all the detected devices.

### Running the Embedded System Diagnostics from the Dell Lifecycle Controller

1. As the system boots, press F11.
2. Select **Hardware Diagnostics** → **Run Hardware Diagnostics**.  
The **ePSA Pre-boot System Assessment** window is displayed, listing all devices detected in the system. The diagnostics starts executing the tests on all the detected devices.

## System diagnostics controls

Menu	Description
Configuration	Displays the configuration and status of all detected devices.
Results	Displays the results of all tests that are executed.
System health	Provides the current overview of the system performance.
Event log	Displays a time-stamped log of the results of all tests run on the system. This is displayed if at least one event description is recorded.

# Jumpers and connectors

## System board jumpers and connectors

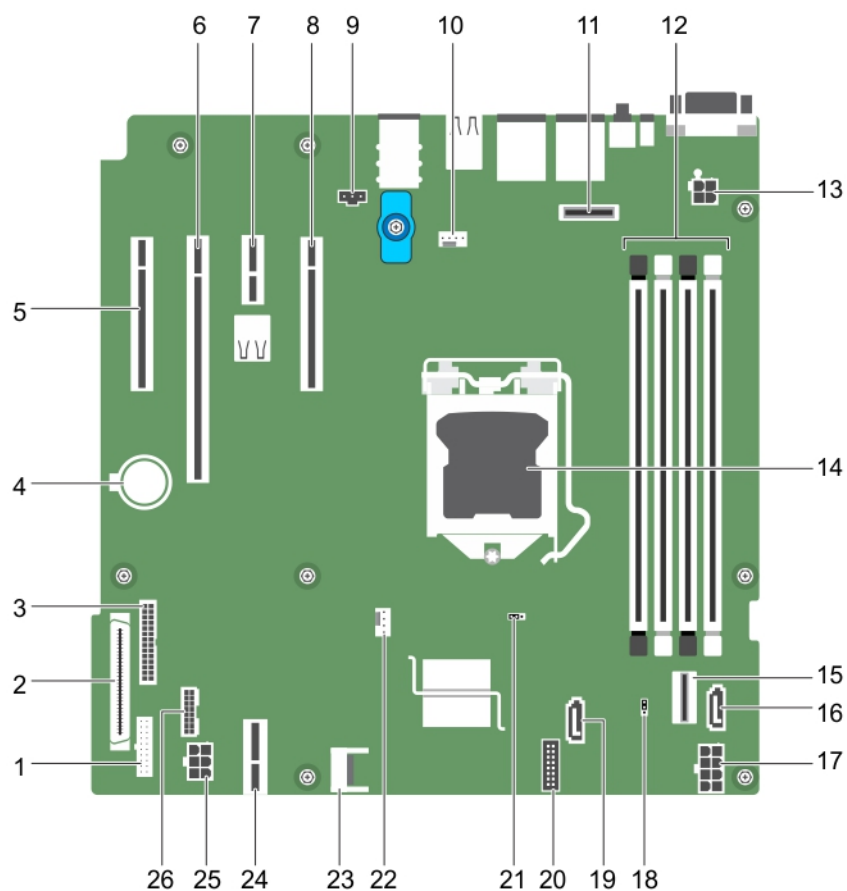

Figure 37. System board jumpers and connectors

Table 10. System board jumpers and connectors

Item	Connector	Description
1	FP_USB	Front panel USB connector
2	CTRL_PNL	Control panel





<b>Item</b>	<b>Connector</b>	<b>Description</b>
3	PIB_CONN	PIB connector
4	BATTERY	System battery
5	Slot 1 PCIe_G3_X4 CPU	PCIe card connector 1
6	Slot 2 PCIe_G3_X8 CPU	PCIe card connector 2
7	Slot 3 PCIe_G3_X1 PCH	PCIe card connector 3
8	Slot 4 PCIe_G3_X4 PCH	PCIe card connector 4
9	J_INTRU2	Intrusion connector
10	MB / Fan1	Cooling fan connector
11	J_AMEA1	iDRAC port card connector
12	A1, A2, A3, A4	Memory module sockets
13	CPU_PWR	CPU power connector P2
14	CPU	Processor socket
15	SATA 0–3/SATAe	Mini SAS connector
16	SATA_ODD/SSD	Optical disk drive connector
17	SYS_PWR	System power connector P1
18	PWRD_EN	Password jumper
19	J_SATA_2	SATA connector 2
20	CTRL_PNL	Control panel connector
21	NVRAM_CLR	NVRAM password jumper
22	CPU_FAN	CPU fan connector
23	TPM	Trusted platform module connector
24	IDSMD	Internal dual SD module connector
25	HDD/ODD_PWR	Hard drive power connector
26	BP_SIG	Backplane signal connector

# System board jumper settings

**CAUTION:** Many repairs may only be done by a certified service technician. You should only perform troubleshooting and simple repairs as authorized in your product documentation, or as directed by the online or telephone service and support team. Damage due to servicing that is not authorized by Dell is not covered by your warranty. Read and follow the safety instructions that came with the product.

For information about resetting the password jumper to disable a password, see [Disabling a forgotten password](#).

**Table 11. System Board Jumper settings**

Jumper	Setting	Description
PWRD_EN	 1 2 3 (default)	The password feature is enabled (pins 1–2).
	 1 2 3	The password feature is disabled (pins 2–3).
NVRAM_CLR	 1 2 3 (default)	The configuration settings are retained at system boot (pins 2–3).
	 1 2 3	The configuration settings are cleared at the next system boot. (pins 1–2).

## Disabling a forgotten password

The system's software security features include a system password and a setup password. The password jumper enables these password features or disables them and clears any password(s) currently in use.

### Prerequisites

**CAUTION:** Many repairs may only be done by a certified service technician. You should only perform troubleshooting and simple repairs as authorized in your product documentation, or as directed by the online or telephone service and support team. Damage due to servicing that is not authorized by Dell is not covered by your warranty. Read and follow the safety instructions that came with the product.

### Steps

1. Turn off the system, including any attached peripherals, and disconnect the system from the electrical outlet.
2. Remove the system cover.
3. Move the jumper on the system board jumper from pins 2 and 3 to pins 1 and 2.
4. Install the system cover.

The existing passwords are not disabled (erased) until the system boots with the jumper on pins 1 and 2. However, before you assign a new system and/or setup password, you must move the jumper back to pins 2 and 3.

 **NOTE:** If you assign a new system and/or setup password with the jumper on pins 1 and 2, the system disables the new password(s) the next time it boots.

5. Reconnect the system to its electrical outlet and turn on the system, including any attached peripherals.



- 6.** Turn off the system, including any attached peripherals, and disconnect the system from the electrical outlet.
- 7.** Remove the system cover.
- 8.** Move the jumper on the system board jumper from pins 1 and 2 to pins 2 and 3.
- 9.** Install the system cover.
- 10.** Reconnect the system to its electrical outlet and turn on the system, including any attached peripherals.
- 11.** Assign a new system or setup password.

# Technical specifications

## Dimensions and weight

Physical	Dimensions
Height	363 mm (14.2913 inches) with rubber pads
Width	175 mm (6.8 inches)
Depth	454 mm (17.87 inches)
Weight	11.5 kg (25.35 lbs)

## Processor specifications

Processor	Specification
Type	One Intel E3-1200 V5 series

## Expansion bus specifications



PCI Express expansion slots	Specification
Slot 1	One full-height, half-length x4 PCIe Gen3 card slot connected to processor
Slot 2	One full-height, half-length x8 PCIe Gen3 card slot connected to processor
Slot 3	One full-height, full-length x1 PCIe Gen3 card slot connected to Platform Controller Hub (PCH)
Slot 4	One full-height, full-length x4 PCIe Gen3 card slot connected to PCH

## Memory specifications

Memory	Specification
Architecture	1600 MT/s, 1866 MT/s, or 2133 MT/s DDR4 Unbuffered DIMMs Support for advanced ECC or memory optimized operation
Memory module sockets	Four 288-pin sockets

Memory	Specification
Memory module capacities (UDIMM)	4 GB (single-rank), 8 GB (single- and dual-rank), 16 GB (single- and dual-rank)
Minimum RAM	4 GB
Maximum RAM	64 GB

## Power specifications

Power supply unit	Specification
Power rating per power supply unit	290 W (Bronze) AC (100 – 240 V, 50/60 Hz, 5.4 A)
Heat dissipation	989 BTU/hr maximum (290 W power supply)  <b>NOTE:</b> Heat dissipation is calculated by using the power supply wattage rating.
Voltage	100–240 V AC, autoranging, 50/60 Hz  <b>NOTE:</b> This system is also designed to be connected to IT power systems with a phase-to-phase voltage not exceeding 230 V.

## Storage controller specifications

Storage controller	Specification
Storage controller type	PERC H730, PERC H330, PERC H830, PERC S130.  <b>NOTE:</b> Your system supports software RAID S130 and a PERC card. For more information on software RAID, see the Dell PowerEdge RAID Controller (PERC) documentation at <a href="http://Dell.com/storagecontrollermanuals">Dell.com/storagecontrollermanuals</a> .

## Drive specifications

Drives	Specification
Drives	Up to four 3.5-inch, internal, cabled SATA and nearline SAS hard drives.  <b>NOTE:</b> NOTE: The PowerEdge T130 does not support hard drives higher than 5 TB.
Optical Drive	One optional slim SATA DVD-ROM drive or DVD+/- RW drive.

## Connectors specifications

### Back connectors

#### Specification

NIC	Two 10/100/1000 Mbps
Serial	9-pin, DTE, 16550-compatible
USB	Six Hi-Speed USB Host connectors (four USB 2.0 and two USB 3.0)
Video	15-pin VGA
iDRAC8	One optional 1 GbE Ethernet
SD vFlash	One optional SD vFlash memory card



**NOTE:** The card slot is available for use only if the iDRAC8 Enterprise license is installed on your system.

### Front connectors

#### Specification

USB	Two Hi-Speed USB Host connectors (One USB 2.0 and one USB 3.0)
-----	--

### Internal connectors

#### Specification

USB	One 9-pin, USB 3.0-compliant
-----	------------------------------

## Video specifications

### Video

#### Specification

Video type	Integrated Matrox G200
Video memory	16 MB shared

## Environmental specifications



**NOTE:** For additional information about environmental measurements for specific system configurations, see [Dell.com/environmental\\_datasheets](http://Dell.com/environmental_datasheets).

### Temperature

#### Specifications

Storage	-40°C to 65°C (-40°F to 149°F)
Continuous operation (for altitude less than 950 m or 3117 ft)	10°C to 35°C (50°F to 95°F) with no direct sunlight on the equipment.
Maximum temperature	20°C/h (36°F/h)

<b>Temperature gradient (operating and storage)</b>	<b>Specifications</b>
<b>Relative humidity</b>	<b>Specifications</b>
<b>Storage</b>	5% to 95% RH with 33°C (91°F) maximum dew point. Atmosphere must be non-condensing at all times.
<b>Operating</b>	10% to 80% Relative Humidity with 29°C (84.2°F) maximum dew point.
<b>Maximum vibration</b>	<b>Specifications</b>
<b>Operating</b>	0.26 G <sub>rms</sub> at 5 Hz to 350 Hz (all operation orientations).
<b>Storage</b>	1.88 G <sub>rms</sub> at 10 Hz to 500 Hz for 15 min (all six sides tested).
<b>Maximum shock</b>	<b>Specifications</b>
<b>Operating</b>	Six consecutively executed shock pulses in the positive and negative x, y, and z axes of 31G for up to 2.6 ms.
<b>Storage</b>	Six consecutively executed shock pulses in the positive and negative x, y, and z axes (one pulse on each side of the system) of 71 G for up to 2 ms.
<b>Maximum altitude</b>	<b>Specifications</b>
<b>Operating</b>	3048 m (10,000 ft).
<b>Storage</b>	12,000 m (39,370 ft).
<b>Operating temperature de-rating</b>	<b>Specifications</b>
<b>Up to 35 °C (95 °F)</b>	Maximum temperature is reduced by 1°C/300 m (1°F/547 ft) above 950 m (3,117 ft)

The following section defines the limits to help avoid IT equipment damage and/or failure from particulates and gaseous contamination. If the levels of particulates or gaseous pollution are beyond the specified limits and cause equipment damage or failure, you may need to rectify the environmental conditions. Remediation of environmental conditions is the responsibility of the customer.

<b>Particulate contamination</b>	<b>Specifications</b>
<b>Air filtration</b>	Data center air filtration as defined by ISO Class 8 per ISO 14644-1 with a 95% upper confidence limit.
	 <b>NOTE:</b> Applies to data center environments only. Air filtration requirements do not apply to IT equipment designed to be used outside a data center, in environments such as an office or factory floor.

## Particulate contamination

### Specifications

 **NOTE:** Air entering the data center must have MERV11 or MERV13 filtration.

## Conductive dust

Air must be free of conductive dust, zinc whiskers, or other conductive particles.

 **NOTE:** Applies to data center and non-data center environments.

## Corrosive dust

- Air must be free of corrosive dust.
- Residual dust present in the air must have a deliquescent point less than 60% relative humidity.

 **NOTE:** Applies to data center and non-data center environments.

## Gaseous contamination

### Specifications

## Copper coupon corrosion rate

<300 Å/month per Class G1 as defined by ANSI/ISA71.04-1985.

## Silver coupon corrosion rate

<200 Å/month as defined by AHSRAE TC9.9.

 **NOTE:** Maximum corrosive contaminant levels measured at  $\leq 50\%$  relative humidity.

# Getting help

## Contacting Dell

Dell provides several online and telephone-based support and service options. If you do not have an active internet connection, you can find contact information on your purchase invoice, packing slip, bill, or Dell product catalog. Availability varies by country and product, and some services may not be available in your area. To contact Dell for sales, technical assistance, or customer-service issues:

1. Go to **Dell.com/support**.
2. Select your country from the drop-down menu on the bottom right corner of the page.
3. For customized support:
  - a. Enter your system Service Tag in the **Enter your Service Tag** field.
  - b. Click **Submit**.  
The support page that lists the various support categories is displayed.
4. For general support:
  - a. Select your product category.
  - b. Select your product segment.
  - c. Select your product.  
The support page that lists the various support categories is displayed.

## Locating your system Service Tag

Your system is identified by a unique Express Service Code and Service Tag number. The Express Service Code and Service Tag are found on the front of the system by pulling out the information tag. Alternatively, the information may be on a sticker on the chassis of the system. This information is used by Dell to route support calls to the appropriate personnel.

 **NOTE:** The Quick Resource Locator (QRL) code on the information tag is unique to your system. Scan the QRL to get immediate access to your system information using your smart phone or tablet.